

PURA

GSI[®]

Lavabi / Washbasins	
100x50, 80x50, 60x50	p.244
122x46, 102x46, 82x46, 62x46	p.246
102x52, 82x49, 62x48, 52x44	p.248
60x42, 60x37, ø42, ø42h22	p.250
60x38, 50x38, 38x38, ø40	p.252
55x38, 50x35	p.254
<hr/>	
Wc e Bidet / Wc and Bidet	
55x36F, 55x36	p.256
50x36F, 50x36	p.258
55x36F	p.260
55x36F, 55x36	p.262
50x36F, 50x36	p.264
60x38	p.266

Orinatoio / Urinal	
31x39, 25x36	p.268
<hr/>	
Vasca / Bathtub	
190x90	p.270

La collezione Pura si distingue per la razionalità progettuale secondo i valori di semplicità e accuratezza che contraddistinguono GSI. Forme sobrie che sapientemente bilanciano linee rette e morbidi arrotondamenti, frutto di un lungo lavoro di messa a punto a livello di design. Pura si compone di lavabi dalla forma rettangolare o stondata, installabili a incasso o sospensione, con pratici piani d'appoggio che fanno da cornice agli ampi bacini e la possibilità di abbinare portasciugamani dedicati. Inoltre, Pura presenta anche una serie di lavabi da appoggio o semi incasso, disponibili nelle varianti di finiture matt bianco o colorate. Per ambienti ad uso collettivo Pura completa la famiglia di sanitari con due modelli di orinatoio.

The Pura collection stands out for its rational design while embodying the values of simplicity and precision that characterize GSI. Sober forms strike an effective balance between straight lines and supple curves and are the fruit of painstaking planning and design. Pura includes washbasins that are rectangular or with rounded corners, that can be installed into the wall or supported on a surface, with practical countertops that frame the large basins and with the option to be combined with special towel racks. In addition, Pura also includes a set of supported or semi-built-in washbasins that are available in either colored or white matt finishing. For bathrooms environments for public use, the line also offers two models of urinals.

Pura

Lavabi Washbasins

100x50
8844111
p.244



80x50
8843111
p.244



60x50
8836111
p.244



122x46
8840111
p.246



102x46
8833111
p.246



82x46
8838111
p.246



62x46
8839111
p.246



102x52
8825111
p.248



82x49
8826111
p.248



62x48
8827111
p.248



52x44
8830111
p.248



60x42
884211

p.250
p.78 →



60x37
883411

p.250
p.78 →



Ø42
885111

p.250
p.78 →



Ø42 h22
885211

p.250
p.78 →



60x38
883711

p.252
p.80 →



50x38
884711

p.252
p.80 →



38x38
885011

p.252
p.80 →



Ø40
884611

p.252
p.80 →



55x38
724311

p.254



50x35
724711

p.254



Wc e Bidet

Wc and Bidet

55x36/F

881511p.256
p.82 →

55x36

881211**8865111**p.256
p.82 →

50x36/F

881611p.258
p.84 →

50x36

881811**8864111**p.258
p.84 →

55x35/F

881111**8861111**

p.260



55x36/F

881011

p.262



55x36

881411**8862111**

p.262



50x36/F

882011

p.264



50x36

881911**8869111**

p.264



68x38

881711

p.266



Orinatoii Urinal

31x39
769711
p.268



25x36
889711
p.268



Vasca Bathtub

190x90
VAPR90
p.270





100x50 - 8844111

○ Bianco lucido
Glossy white

100x50
8844111



80x50
8843111



60x50
8836111



Dimensione Dimension (cm)	Componente Component	Descrizione Description	○ Cod.	Cm	Kg	245
100x50	Lavabo Washbasin	Lavabo con foro troppopieno monoforo predisposto per rubinetteria triforo. Installazione a sospensione ed incasso. Washbasin with overflow one taphole prearranged for three taphole fittings. Wall-hung and built-in installation.	○ 8844111	100x50	21	
	Portasciugamani Towel rail	Portasciugamani in metallo cromato. Towel rail, in chromed metal.	PAPR100	-		
80x50	Lavabo Washbasin	Lavabo con foro troppopieno monoforo predisposto per rubinetteria triforo. Installazione a sospensione ed incasso. Washbasin with overflow one taphole prearranged for three taphole fittings. Wall-hung and built-in installation.	○ 8843111	80x50		
	Portasciugamani Towel rail	Portasciugamani in metallo cromato. Towel rail, in chromed metal.	PAPR80	-		
60x50	Lavabo Washbasin	** Lavabo con foro troppopieno monoforo predisposto per rubinetteria triforo. Installazione a sospensione ed incasso. Washbasin with overflow one taphole prearranged for three taphole fittings. Wall-hung and built-in installation.	○ 8836111	60x50		
	Portasciugamani Towel rail	Portasciugamani in metallo cromato. Towel rail, in chromed metal.	PAPR60	-		
	Piletta Drain	Chiusura a scatto. Finitura cromo. Snap closure. Chrome finish.	PILL	1" 1/4	0,45	
	Piletta in Ceramica Ceramic Drain	Piletta con chiusura a scatto per lavabo con foro troppopieno, corpo in ottone e coperchio in ceramica. Drain with snap closure for basin with overflow, brass body and ceramic cover plate.	PCS11	-	0,65	
	Sifone Siphon	Sifone tondo in ottone cromato. Siphon round, in chromed brass.	MMBSIF	1" 1/4	1,3	
		Sifone tondo in abs cromato. Siphon round, in chromed abs.	MMBSIFC	1" 1/4	0,3	
	Placca di chiusura Chromed plate	Placca cromata per copertura del foro troppopieno. Chromed plate for overflow covering.	PCT	-	0,05	
	Kit di fissaggio Fixing kit	Kit fissaggio per lavabo sospeso (obbligatorio). Fixing kit for wall-hung washbasin (required).	FLAVABO	-	0,2	

**Disponibile da luglio 2019
Available from July 2019



82x46 - 8838111



102x46 - 8833111

○ Bianco lucido
Glossy white

122x46
8840111



102x46
8833111







82x46
8838111



62x46
8839111



Dimensione Dimension (cm)	Componente Component	Descrizione Description	○ Cod.	Cm	Kg	247
122x46	Lavabo Washbasin	Lavabo con foro troppopieno monoforo predisposto per rubinetteria 5 fori. Installazione a sospensione ed incasso. Washbasin with overflow one taphole prearranged for five taphole fittings. Wall-hung and built-in installation.	○ 8840111	122x46 h17,5	25	
	Portasciugamani Towel rail	Portasciugamani in metallo cromato. Towel rail, in chromed metal.	PAPRD122	-	-	
102x46	Lavabo Washbasin	Lavabo con foro troppopieno monoforo predisposto per rubinetteria triforo. Installazione a sospensione ed incasso. Washbasin with overflow one taphole prearranged for three taphole fittings. Wall-hung and built-in installation.	○ 8833111	102x46 h17,5	19,8	
	Portasciugamani Towel rail	Portasciugamani in metallo cromato. Towel rail, in chromed metal.	PAPRD102	-	-	
82x46	Lavabo Washbasin	Lavabo con foro troppopieno monoforo predisposto per rubinetteria 3 fori. Installazione a sospensione ed incasso. Washbasin with overflow one taphole prearranged for three taphole fittings. Wall-hung and built-in installation.	○ 8838111	82x46 h17,5	16	
	Portasciugamani Towel rail	Portasciugamani in metallo cromato. Towel rail, in chromed metal.	PAPRD82	-	-	
62x46	Lavabo Washbasin	*Lavabo con foro troppopieno monoforo predisposto per rubinetteria triforo. Installazione a sospensione ed incasso. Washbasin with overflow one taphole prearranged for three taphole fittings. Wall-hung and built-in installation.	○ 8839111	62x46 h17,5		
	Portasciugamani Towel rail	Portasciugamani in metallo cromato. Towel rail, in chromed metal.	PAPRD62	-	-	
	Piletta Drain	Chiusura a scatto. Finitura cromo. Snap closure. Chrome finish.	PILL	1" 1/4	0,45	
	Piletta in Ceramica Ceramic Drain	Piletta con chiusura a scatto per lavabo con foro troppopieno, corpo in ottone e coperchio in ceramica. Drain with snap closure for basin with overflow, brass body and ceramic cover plate.	PCS11	-	0,65	
	Sifone Siphon	Sifone tondo in ottone cromato. Siphon round, in chromed brass.	MMBSIF	1" 1/4	1,3	
		Sifone tondo in abs cromato. Siphon round, in chromed abs.	MMBSIFC	1" 1/4	0,3	
	Placca di chiusura Chromed plate	Placca cromata per copertura del foro troppopieno. Chromed plate for overflow covering.	PCT	-	0,05	
	Kit di fissaggio Fixing kit	Kit fissaggio per lavabo sospeso (obbligatorio). Fixing kit for wall-hung washbasin (required).	FLAVABO	-	0,2	

*Disponibile da luglio 2019
Available from July 2019



102x52 - 8825111



102x52 - 8825111

○ Bianco lucido
Glossy white

102x52
8825111



82x49
8826111







62x48
8827111



52x44
8830111



Dimensione Dimension (cm)	Componente Component	Descrizione Description	○ Cod.	Cm	Kg	249
102x52	Lavabo Washbasin	Lavabo con foro troppopieno monoforo predisposto per rubinetteria triforo. Installazione a sospensione ed incasso. Washbasin with overflow one taphole prearranged for three taphole fittings. Wall-hung and built-in installation.	○ 8825111	102x52 h19	21,2	
	Portasciugamani Towel rail	Portasciugamani in metallo cromato. Towel rail, in chromed metal.	PAPR102	-	0,7	
82x49	Lavabo Washbasin	Lavabo con foro troppopieno monoforo predisposto per rubinetteria triforo. Installazione a sospensione ed incasso. Washbasin with overflow one taphole prearranged for three taphole fittings. Wall-hung and built-in installation.	○ 8826111	82x49 h19	15,3	
	Portasciugamani Towel rail	Portasciugamani in metallo cromato. Towel rail, in chromed metal.	PAPR82	-	0,7	
62x48	Lavabo Washbasin	Lavabo con foro troppopieno monoforo predisposto per rubinetteria triforo. Installazione a sospensione ed incasso. Washbasin with overflow one taphole prearranged for three taphole fittings. Wall-hung and built-in installation.	○ 8827111	62x48 h19	11,1	
	Portasciugamani Towel rail	Portasciugamani in metallo cromato. Towel rail, in chromed metal.	PAPR62	-	-	
52x44	Lavabo Washbasin	Lavabo con foro troppopieno monoforo predisposto per rubinetteria triforo. Installazione a sospensione ed incasso. Washbasin with overflow one taphole prearranged for three taphole fittings. Wall-hung and built-in installation.	○ 8830111	52x44 h19	9,2	
	Piletta Drain	Chiusura a scatto. Finitura cromo. Snap closure. Chrome finish.	PILL	1" 1/4	0,45	
	Piletta in Ceramica Ceramic Drain	Piletta con chiusura a scatto per lavabo con foro troppopieno, corpo in ottone e coperchio in ceramica. Drain with snap closure for basin with overflow, brass body and ceramic cover plate.	PCS11	-	0,65	
	Sifone Siphon	Sifone tondo in ottone cromato. Siphon round, in chromed brass.	MMBSIF	1" 1/4	1,3	
		Sifone tondo in abs cromato. Siphon round, in chromed abs.	MMBSIFC	1" 1/4	0,3	
	Placca di chiusura Chromed plate	Placca cromata per copertura del foro troppopieno. Chromed plate for overflow covering.	PCT	-	0,05	
	Kit di fissaggio Fixing kit	Kit fissaggio per lavabo sospeso (obbligatorio). Fixing kit for wall-hung washbasin (required).	FLAVABO	-	0,2	



60x42 - 884211





60x37 - 883411





Ø42 - 885151



Ø42 h22 - 885211

-  Bianco lucido
Glossy white
-  Bianco opaco
Matt white
-  Agave

-  Ardesia
-  Bistro
-  Cenere

-  Creta
-  Ghiaccio
-  Tortora

-  Oro-Nero
Gold-Black
-  Oro-Bianco
Gold-White
-  Platino-Bianco
Platinum-White

60x42 884211

Opzione colore

Color options

- 884209** Bianco opaco
- 884204** Agave
- 884226** Ardesia
- 884216** Bistro
- 884217** Cenere
- 884208** Creta
- 884215** Ghiaccio
- 884205** Tortora
- 884251** Oro-Nero
- 884250** Oro-Bianco
- 884255** Platino-Bianco



60x37 883411

Opzione colore

Color options

- 883409** Bianco opaco
- 883404** Agave
- 883426** Ardesia
- 883416** Bistro
- 883417** Cenere
- 883408** Creta
- 883415** Ghiaccio
- 883405** Tortora
- 883451** Oro-Nero
- 883450** Oro-Bianco
- 883455** Platino-Bianco



Ø42 885111

Opzione colore

Color options

- 885109** Bianco opaco
- 885104** Agave
- 885126** Ardesia
- 885116** Bistro
- 885117** Cenere
- 885108** Creta
- 885115** Ghiaccio
- 885105** Tortora
- 885151** Oro-Nero
- 885150** Oro-Bianco
- 885155** Platino-Bianco



Ø42 h22 885211

Opzione colore



Color options

- 885209** Bianco opaco
- 885204** Agave
- 885226** Ardesia
- 885216** Bistro
- 885217** Cenere
- 885208** Creta
- 885215** Ghiaccio
- 885205** Tortora



Solo per bianco lucido
Only for glossy white

Solo per oro e platino
Only for gold and platinum

Dimensione Dimension (cm)	Componente Component	Descrizione Description	Cod.	Cm	Kg
60x42	Lavabo Washbasin	Lavabo senza foro troppopieno predisposto per rubinetteria da parete o su piano. Installazione ad appoggio. Washbasin with no overflow, prearranged for wall or countertop tap fittings. Countertop installation.	○ 884211 ● ● ● ●	60x42 h 16	9,9
60x37	Lavabo Washbasin	Lavabo senza foro troppopieno predisposto per rubinetteria da parete o su piano. Installazione ad appoggio. Washbasin with no overflow, prearranged for wall or countertop tap fittings. Countertop installation.	○ 883411 ● ● ● ●	60x37 h 16	11
Ø42	Lavabo Washbasin	Lavabo senza foro troppopieno predisposto per rubinetteria da parete o su piano. Installazione ad appoggio. Washbasin with no overflow, prearranged for wall or countertop tap fittings. Countertop installation.	○ 885111 ● ● ● ●	Ø42 h 16	7,8
Ø42 h22	Lavabo Washbasin	Lavabo senza foro troppopieno predisposto per rubinetteria da parete o su piano. Installazione ad appoggio. Washbasin with no overflow, prearranged for wall or countertop tap fittings. Countertop installation.	○ 885211 ●	Ø42 h22	10
	Piletta Drain	Piletta con apertura fissa. Finitura cromo (consigliato). Drain with standard opening. Chrome finish (recommended).	PILLV	1" 1/4	0,4
	Piletta in Ceramica Ceramic Drain	Piletta con apertura fissa per lavabo senza foro troppopieno, corpo in ottone e coperchio in ceramica. Drain with standard opening for basin with no overflow, brass body and ceramic cover plate.	○ PVC11 ● PVC09 ● PVC04 ● PVC26 ● PVC16 ● PVC17 ● PVC08 ● PVC15 ● PVC05 ● PVC20	- -	0,65 0,65
	Sifone Siphon	Sifone tondo in ottone cromato. Siphon round, in chromed brass.	MMBSIF	1" 1/4	1,3
		Sifone tondo in abs cromato. Siphon round, in chromed abs.	MMBSIFC	1" 1/4	0,3



60x38 - 883711

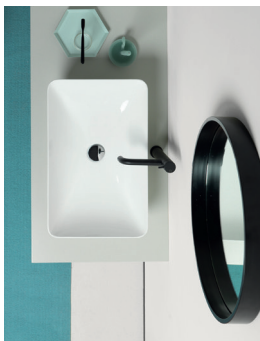

60x38 - 883711



Ø40 - 884615



60x38 - 883704

- Bianco lucido
Glossy white
- ◐ Bianco opaco
Matt white
- Agave

- Ardesia
- Bistro
- Cenere

- Creta
- Ghiaccio
- Tortora

60x38
883711

Opzione colore**Color options**

- 883709 Bianco opaco
- 883704 Agave
- 883726 Ardesia
- 883716 Bistro
- 883717 Cenere
- 883708 Creta
- 883715 Ghiaccio
- 883705 Tortora



50x38
884711

Opzione colore**Color options**

- 884709 Bianco opaco
- 884704 Agave
- 884726 Ardesia
- 884716 Bistro
- 884717 Cenere
- 884708 Creta
- 884715 Ghiaccio
- 884705 Tortora



38x38
885011

Opzione colore**Color options**

- 885009 Bianco opaco
- 885004 Agave
- 885026 Ardesia
- 885016 Bistro
- 885017 Cenere
- 885008 Creta
- 885015 Ghiaccio
- 885005 Tortora





Ø40
884611

Opzione colore**Color options**

- 884609 Bianco opaco
- 884604 Agave
- 884626 Ardesia
- 884616 Bistro
- 884617 Cenere
- 884608 Creta
- 884615 Ghiaccio
- 884605 Tortora



Solo per bianco lucido
Only for glossy white

Dimensione Dimension (cm)	Componente Component	Descrizione Description	○ Cod.	Cm	Kg
60x38	Lavabo Washbasin	Lavabo senza foro troppopieno predisposto per rubinetteria da parete o su piano. Installazione ad appoggio o ad incasso. Washbasin with no overflow, prearranged for wall or countertop tap fittings. Countertop or built-in installation.	○ 883711 ●	60x38 60x38	12,8
50x38	Lavabo Washbasin	Lavabo senza foro troppopieno predisposto per rubinetteria da parete o su piano. Installazione ad appoggio o ad incasso. Washbasin with no overflow, prearranged for wall or countertop tap fittings. Countertop or built-in installation.	○ 884711 ●	50x38 50x38	10,1
38x38	Lavabo Washbasin	Lavabo senza foro troppopieno predisposto per rubinetteria da parete o su piano. Installazione ad appoggio o ad incasso. Washbasin with no overflow, prearranged for wall or countertop tap fittings. Countertop or built-in installation.	○ 885011 ●	38x38 38x38	8,7
Ø40	Lavabo Washbasin	Lavabo senza foro troppopieno predisposto per rubinetteria da parete o su piano. Installazione ad appoggio o ad incasso. Washbasin with no overflow, prearranged for wall or countertop tap fittings. Countertop or built-in installation.	○ 884611 ●	Ø40 Ø40	7,5
	Piletta Drain	Piletta con apertura fissa. Finitura cromo (consigliato). Drain with standard opening. Chrome finish (recommended).	PILLV	1" 1/4	0,4
	Piletta in Ceramica Ceramic Drain	Piletta con apertura fissa per lavabo senza foro troppopieno, corpo in ottone e coperchio in ceramica. Drain with standard opening for basin with no overflow, brass body and ceramic cover plate.	○ PVC11 ○ PVC09 ● PVC04 ● PVC26 ● PVC16 ● PVC17 ● PVC08 ● PVC15 ● PVC05	- -	0,65 0,65
	Sifone Siphon	Sifone tondo in ottone cromato. Siphon round, in chromed brass.	MMBSIF	1" 1/4	1,3
		Sifone tondo in abs cromato. Siphon round, in chromed abs.	MMBSIFC	1" 1/4	0,3



55x38 - 724311





○ Bianco lucido
Glossy white

55x38
724311



50x35
724711



Dimensione Dimension (cm)	Componente Component	Descrizione Description	○ Cod.	Cm	Kg	255
55x38	Lavabo Washbasin	Lavabo con foro troppopieno predisposto per rubinetteria da parete o su piano. Installazione a sottopiano. Washbasin with overflow, prearranged for wall or countertop tap fittings. Under-counter installation.	○ 724311	55x38	8	
50x35	Lavabo Washbasin	Lavabo con foro troppopieno predisposto per rubinetteria da parete o su piano. Installazione a sottopiano. Washbasin with overflow, prearranged for wall or countertop tap fittings. Under-counter installation.	○ 724711	50x35	7,6	
	Piletta Drain	Chiusura a scatto. Finitura cromo. Snap closure. Chrome finish.	PILL	1" 1/4	0,45	
	Piletta in Ceramica Ceramic Drain	Piletta con chiusura a scatto per lavabo con foro troppopieno, corpo in ottone e coperchio in ceramica. Drain with snap closure for basin with overflow, brass body and ceramic cover plate.	PCS11	-	0,65	
	Kit di fissaggio Fixing kit	Fissaggio per lavabo sottopiano. Fixing screw kit for under-counter installation.	FV	-	0,15	
	Placca di chiusura Chromed plate	Placca cromata per copertura del foro troppopieno. Chromed plate for overflow covering.	PCT	-	0,05	
	Sifone Siphon	Sifone tondo in ottone cromato. Siphon round, in chromed brass.	MMBSIF	1" 1/4	1,3	
		Sifone tondo in abs cromato. Siphon round, in chromed abs.	MMBSIFC	1" 1/4	0,3	



55x36 - 881211 - 8865111



55x36/F - 881504 - 8865104



55x36/F - 881515 - 8865115



55x36/F - 881508 - 8865108

- | | | | |
|-------------------------------|---------|----------|----------------------------------|
| Bianco lucido
Glossy white | Ardesia | Creta | Oro-Nero
Gold-Black |
| Bianco opaco
Matt white | Bistro | Ghiaccio | Oro-Bianco
Gold-White |
| Agave | Cenera | Tortora | Platino-Bianco
Platinum-White |

55x36/F
881511
8865111

- Opzione colore**
Color options
- 881510 - 8865109** Bianco opaco
 - 881504 - 8865104** Agave
 - 881526 - 8865126** Ardesia
 - 881516 - 8865116** Bistro
 - 881517 - 8865117** Cenera
 - 881508 - 8865108** Creta
 - 881515 - 8865115** Ghiaccio
 - 881505 - 8865105** Tortora
 - 881551 - 8865151** Oro-Nero
 - 881550 - 8865150** Oro-Bianco
 - 881555 - 8865155** Platino-Bianco



55x36
881211
8865111













Solo per
Only for
881511

Solo per
Only for
881211

Solo per oro e platino
Only for gold and platinum



Dimensione Dimension (cm)	Componente Component	Descrizione Description	Cod.	Cm	Kg	257
55x36/F	Wc sospeso Wall-hung wc	* Wc installazione a sospensione con sistema di scarico Swirlflush® . Wall-hung wc with Swirlflush® system.	○ 881511 ● ● ● ●	55x36	18,5	
	Wc sospeso Wall-hung wc	Wc installazione a sospensione con sistema di fissaggio dal basso. Wall-hung wc installation with concealed fixing.	○ 881211	55x36	23,7	
55x36	Bidet sospeso Wall-hung bidet	Bidet sospeso monoforo con foro troppopieno e sistema di fissaggio dal basso. Single hole wall-hung bidet with overflow and concealed fixing.	○ 8865111 ● ● ● ●	55x36	17	
	 Sedile Slim "soft-close" Seat & cover Slim "soft-close"	Sedile "Soft-Close" Slim in resina termoindurente. Seat & Cover "Soft-Close" Slim, in thermosetting resin.	○ MS86CSN11 ● ● ●			2,8
 Sedile "soft-close" Seat & cover "soft-close"	Sedile "Soft-Close" in resina termoindurente. Seat & Cover "Soft-Close", in thermosetting resin.	○ MS86CN11 ● ● ●		-	3,3	
 Sedile Seat & cover	Sedile in resina termoindurente. Seat & Cover, in thermosetting resin.	○ MS86N11 ● ● ●		-	3,3	
 Sedile Contract "soft-close" Contract seat & cover "soft-close"	Sedile "Soft-Close" in resina termoindurente. Seat & Cover "Soft-Close", in thermosetting resin.	MS99C11 ● ● ●		-	2,4	
 Sedile Contract Contract seat & cover	Sedile in resina termoindurente. Seat & Cover, in thermosetting resin.	MS9911 ● ● ●		-	2,4	
 Piletta Drain	Chiusura a scatto. Finitura cromo. Snap closure. Chrome finish.	PILL ● ● ●		1" 1/4	0,45	
 Piletta in Ceramica Ceramic Drain	Piletta con chiusura a scatto per lavabo con foro troppopieno, corpo in ottone e coperchio in ceramica. Drain with snap closure for basin with overflow, brass body and ceramic cover plate.	○ PCS11 ○ PCS09 ● PCS04 ● PCS26 ● PCS16 ● PCS17 ● PCS08 ● PCS15 ● PCS05 ● PCS20		-	0,65 0,65	
 Protezione Protection	Protezione insonorizzante per wc o bidet sospeso. Soundproof protection for wall-hung wc or bidet.	MPR ● ● ●		-	-	
 Staffe di fissaggio Fixing brackets	Staffe di fissaggio per wc o bidet. Fixing brackets for wc or bidet.	FSOSP ● ● ●		-	3,8	
 Placca di chiusura Chromed plate	Placca cromata per copertura del foro troppopieno. Chromed plate for overflow covering.	PCT ● ● ●		-	0,05	
 Fissaggio rapido Quick fixing screw	Fissaggio a scomparsa dal basso (obbligatorio 1 kit per articolo) Concealed fixing (1 kit required for article)	FISR2 ● ● ●		-	0,3	

*Non è consigliato l'impiego di cassette di scarico esterne o impianti dotati di rubinetto flussometro.
We do not recommend the use of external flushing cisterns or systems endowed with flushometer valves.

● Color Elements





50x36/F - 881605 - 8864105



50x36/F - 881611



50x36/F - 881626

-  Bianco lucido
Glossy white
-  Bianco opaco
Matt white
-  Agave

-  Ardesia
-  Bistro
-  Cenera

-  Creta
-  Ghiaccio
-  Tortora

50x36/F
881611
8864111

Opzione colore**Color options**

- 881610 - 8864109** Bianco opaco
- 881604 - 8864104** Agave
- 881626 - 8864126** Ardesia
- 881616 - 8864116** Bistro
- 881617 - 8864117** Cenera
- 881608 - 8864108** Creta
- 881615 - 8864115** Ghiaccio
- 881605 - 8864105** Tortora



50x36
881811
8864111



Solo per
Only for
881611



swirlflush®



extraglaze®



save water



quickrelease













softclose



dualglaze

Solo per
Only for
881811

Dimensione Dimension (cm)	Componente Component	Descrizione Description	○ Cod.	Cm	Kg
50x36/F	Wc sospeso Wall-hung wc	* Wc installazione a sospensione con sistema di scarico Swirflush® . Wall-hung wc with Swirflush® system.	○ 881611 ● → p.85	50x36	22,8
	Wc sospeso Wall-hung wc	Wc installazione a sospensione con sistema di fissaggio dal basso. Wall-hung wc installation with concealed fixing.	○ 881811	50x36	18,5
50x36	Bidet sospeso Wall-hung bidet	Bidet sospeso monoforo con foro troppopieno e sistema di fissaggio dal basso. Single hole wall-hung bidet with overflow and concealed fixing.	○ 8864111 ● → p.85	50x36	16,3
	 Sedile Slim "soft-close" Seat & cover Slim "soft-close"	Sedile "Soft-Close" Slim in resina termoindurente. Seat & Cover "Soft-Close" Slim, in thermosetting resin.	○ MS86CSN11 ● → p.85		2,8
 Sedile "soft-close" Seat & cover "soft-close"	Sedile "Soft-Close" in resina termoindurente. Seat & Cover "Soft-Close", in thermosetting resin.	○ MS86CN11	-	3,3	
 Sedile Seat & cover	Sedile in resina termoindurente. Seat & Cover, in thermosetting resin.	○ MS86N11	-	3,3	
 Sedile Contract "soft-close" Contract seat & cover "soft-close"	Sedile "Soft-Close" in resina termoindurente. Seat & Cover "Soft-Close", in thermosetting resin.	MS99C11	-	2,4	
	Sedile Contract Contract seat & cover	Sedile in resina termoindurente. Seat & Cover, in thermosetting resin.	MS9911	-	2,4
 Piletta Drain	Chiusura a scatto. Finitura cromo. Snap closure. Chrome finish.	PILL	1" 1/4	0,45	
 Piletta in Ceramica Ceramic Drain	Piletta con chiusura a scatto per lavabo con foro troppopieno, corpo in ottone e coperchio in ceramica. Drain with snap closure for basin with overflow, brass body and ceramic cover plate.	○ PCS11	-	0,65	
		○ PCS09	-	0,65	
		● PCS04			
		● PCS26			
		● PCS16			
		● PCS17			
		● PCS08			
 Protezione Protection	Protezione insonorizzante per wc o bidet sospeso. Soundproof protection for wall-hung wc or bidet.	MPR	-	-	
 Staffe di fissaggio Fixing brackets	Staffe di fissaggio per wc o bidet. Fixing brackets for wc or bidet.	FSOSP	-	3,8	
 Placca di chiusura Chromed plate	Placca cromata per copertura del foro troppopieno. Chromed plate for overflow covering.	PCT	-	0,05	
 Fissaggio rapido Quick fixing screw	Fissaggio a scomparsa dal basso (obbligatorio 1 kit per articolo) Concealed fixing (1 kit required for article)	FISR2	-	0,3	

*Non è consigliato l'impiego di cassette di scarico esterne o impianti dotati di rubinetto flussometro.
We do not recommend the use of external flushing cisterns or systems endowed with flushometer valves.

● Color Elements





55x35/F - 881111 - 8861111

○ Bianco lucido
Glossy white

55x35/F
881111
8861111



Dimensione Dimension (cm)	Componente Component	Descrizione Description	○ Cod.	Cm	Kg	261
55x35/F	Wc sospeso Wall-hung wc	* Wc "eco" installazione a sospensione. Wall-hung wc "eco" installation.	○ 881111	54,5x35	23,3	
	Bidet sospeso Wall-hung bidet	Bidet sospeso "eco" monoforo con foro troppopieno. Single hole wall-hung bidet "eco" with overflow.	○ 8861111	54,5x35	17,1	
	Sedile "soft-close" Seat & cover "soft-close"	Sedile "Soft-Close" in resina termoindurente. Seat & Cover "Soft-Close", in thermosetting resin.	MS91C11	-	2,2	
	Sedile Seat & cover	Sedile in resina termoindurente. Seat & Cover, in thermosetting resin.	MS9111	-	2,2	
	Protezione Protection	Protezione insonorizzante per wc o bidet sospeso. Soundproof protection for wall-hung wc or bidet.	MPR	-	-	
	Staffe di fissaggio Fixing brackets	Staffe di fissaggio per wc o bidet. Fixing brackets for wc or bidet.	FSOSP	-	3,8	

*Non è consigliato l'impiego di cassette di scarico esterne o impianti dotati di rubinetto flussometro.
We do not recommend the use of external flushing cisterns or systems endowed with flushometer valves.



55x36 - 881411 - 8862111

○ Bianco lucido
Glossy white

55x36/F
881011
8862111



55x36
881411
8862111



Solo per
Only for
881011

Solo per
Only for
881411



swirlflush®



extraglaze®













save water



quickrelease



softclose

Dimensione Dimension (cm)	Componente Component	Descrizione Description	Cod.	Cm	Kg
55x36/F	Wc Wc	* Wc predisposto per scarico a parete oppure a pavimento tramite curva tecnica, con sistema di scarico Swirflush® Wall wc with or floor outlet (through pipe fitting), with Swirflush® system.	○ 881011	55x36	23,5
	Bidet Bidet	Bidet monoforo con foro troppopieno. One taphole bidet with overflow hole.	○ 8862111	55x36	23,1
55x36	Wc Wc	Wc predisposto per scarico a parete oppure a pavimento tramite curva tecnica. Wall wc with or floor outlet (through pipe fitting).	○ 881411	55x36	24,5
	Bidet Bidet	Bidet monoforo con foro troppopieno. One taphole bidet with overflow hole.	○ 8862111	55x36	23,1
	Sedile Slim "soft-close" Seat & cover Slim "soft-close"	Sedile "Soft-Close" Slim in resina termoindurente. Seat & Cover "Soft-Close" Slim, in thermosetting resin.	MS86CSN11	-	2,8
	Sedile "soft-close" Seat & cover "soft-close"	Sedile "Soft-Close" in resina termoindurente. Seat & cover "Soft-Close", of thermosetting resin.	MS86CN11	-	3,35
	Sedile Seat & cover	Sedile in resina termoindurente. Seat & cover, of thermosetting resin.	MS86N11	-	3,35
	Sedile Contract "soft-close" Contract seat & cover "soft-close"	Sedile "Soft-Close" in resina termoindurente. Seat & Cover "Soft-Close", in thermosetting resin.	MS99C11	-	2,4
	Sedile Contract Contract seat & cover	Sedile in resina termoindurente. Seat & Cover, in thermosetting resin.	MS9911	-	2,4
	Piletta Drain	Chiusura a scatto. Finitura cromo. Snap closure. Chrome finish.	PILL	1" 1/4	0,45
	Piletta in Ceramica Ceramic Drain	Piletta con chiusura a scatto per lavabo con foro troppopieno, corpo in ottone e coperchio in ceramica. Drain with snap closure for basin with overflow, brass body and ceramic cover plate.	PCS11	-	0,65 0,65
	Curva tecnica Technical curve	Curva tecnica. Technical curve.	MCURVA	ø 11	0,35
		Kit fissaggio curva Fixing kit curve	FISC	-	0,2
	Curva tecnica a S Technical curve S	Curva tecnica a S per wc con fissaggio per traslare scarico. Technical curve S shape for wc with fixing included, for translate outlet.	MCURVAS	ø 11	0,9
	Raccordo Pipe	Raccordo entrata acqua eccentrico ± 1,5 cm. Water inlet connector eccentric ± 1,5 cm.	RACT	-	0,1
	Placca di chiusura Chromed plate	Placca cromata per copertura del foro troppopieno. Chromed plate for overflow covering.	PCT	-	0,05
	Kit di fissaggio Fixing screw	Kit di fissaggio orizzontale per wc o bidet. Finitura cromo e bianco. Consigliato. Fixing screw horizontal for wc or bidet. Chrome and white finish. Recommended.	FVB	-	0,1

*Non è consigliato l'impiego di cassette di scarico esterne o impianti dotati di rubinetto flussometro.
We do not recommend the use of external flushing cisterns or systems endowed with flushometer valves.



50x36 - 881911 - 8869111

○ Bianco lucido
Glossy white

50x36/F
882011
8869111



50x36
881911
8869111



Solo per
Only for
882011



swirlflush®



extraglaze®



save water













quickrelease



softclose

Solo per
Only for
881911

Dimensione Dimension (cm)	Componente Component	Descrizione Description	Cod.	Cm	Kg
50x36/F	Wc Wc	* Wc predisposto per scarico a parete oppure a pavimento tramite curva tecnica, con sistema di scarico Swirflush® Wall wc with or floor outlet (through pipe fitting), with Swirflush® system.	○ 882011	50x36	25
	Bidet Bidet	Bidet monoforo con foro troppopieno. One taphole bidet with overflow hole.	○ 8869111	50x36	18
50x36	Wc Wc	Wc predisposto per scarico a parete oppure a pavimento tramite curva tecnica. Wall wc with or floor outlet (through pipe fitting).	○ 881911	50x36	23,5
	Bidet Bidet	Bidet monoforo con foro troppopieno. One taphole bidet with overflow hole.	○ 8869111	50x36	18
	Sedile Slim "soft-close" Seat & cover Slim "soft-close"	Sedile "Soft-Close" Slim in resina termoindurente. Seat & Cover "Soft-Close" Slim, in thermosetting resin.	MS86CSN11	-	2,8
	Sedile "soft-close" Seat & cover "soft-close"	Sedile "Soft-Close" in resina termoindurente. Seat & cover "Soft-Close", of thermosetting resin.	MS86CN11	-	3,35
	Sedile Seat & cover	Sedile in resina termoindurente. Seat & cover, of thermosetting resin.	MS86N11	-	3,35
	Sedile Contract "soft-close" Contract seat & cover "soft-close"	Sedile "Soft-Close" in resina termoindurente. Seat & Cover "Soft-Close", in thermosetting resin.	MS99C11	-	2,4
	Sedile Contract Contract seat & cover	Sedile in resina termoindurente. Seat & Cover, in thermosetting resin.	MS9911	-	2,4
	Piletta Drain	Chiusura a scatto. Finitura cromo. Snap closure. Chrome finish.	PILL	1" 1/4	0,45
	Piletta in Ceramica Ceramic Drain	Piletta con chiusura a scatto per lavabo con foro troppopieno, corpo in ottone e coperchio in ceramica. Drain with snap closure for basin with overflow, brass body and ceramic cover plate.	PCS11	- -	0,65 0,65
	Curva tecnica Technical curve	Curva tecnica. Technical curve.	MCURVA	ø 11	0,35
		Kit fissaggio curva Fixing kit curve	FISC	-	0,2
	Curva tecnica a S Technical curve S	Curva tecnica a S per wc con fissaggio per traslare scarico. Technical curve S shape for wc with fixing included, for translate outlet.	MCURVAS	ø 11	0,9
	Raccordo Pipe	Raccordo entrata acqua eccentrico ± 1,5 cm. Water inlet connector eccentric ± 1,5 cm.	RACT	-	0,1
	Placca di chiusura Chromed plate	Placca cromata per copertura del foro troppopieno. Chromed plate for overflow covering.	PCT	-	0,05
	Kit di fissaggio Fixing screw	Kit di fissaggio orizzontale per wc o bidet. Finitura cromo e bianco. Consigliato. Fixing screw horizontal for wc or bidet. Chrome and white finish. Recommended.	FVB	-	0,1

*Non è consigliato l'impiego di cassette di scarico esterne o impianti dotati di rubinetto flussometro.
We do not recommend the use of external flushing cisterns or systems endowed with flushometer valves.



68x38 - 881711

○ Bianco lucido
Glossy white

68x38^a
881711











68x38^b
881711

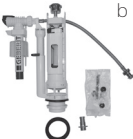

extraglaze®

quickrelease

softclose

Dimensione Dimension (cm)	Componente Component	Descrizione Description	○ Cod.	Cm	Kg	267
68x36	Wc monoblocco Close coupled wc	Wc monoblocco con scarico a parete trasformabile a pavimento tramite curva tecnica non a corredo. Close coupled wc with horizontal outlet convertible to floor outlet through a technical curve not included in set.	○ 881711	68x36	33,3	
	a Scocca in ceramica Ceramic cover for plastic cistern tank	Copertura in ceramica con predisposizione entrata acqua dal retro, laterale destra o sinistra per meccanismo anticondensa. Ceramic cover pre-arranged for water entry from the back, lateral left or right for anti-condensation mechanism.	869111	13x35,5 h46	9,7	
	a Batteria di scarico anticondensa Anti-condensation mechanism	Batteria di scarico anticondensa doppio flusso 3/6 lt. con entrata acqua laterale e posteriore. Finitura cromo. Anti-condensation mechanism with dual flush 3/6 lt with bottom, side, and back water entry. Chrome finish.	BSCR	-	2,1	
	b Cassetta Cistern	Cassetta per monoblocco con entrata acqua dal retro, dal basso o dall'alto (predisposizione destra o sinistra). Cistern for cc pan with back, high or bottom water entry (prearranged for right or left).	868111	117x31 h43	13,5	
	b Batteria di scarico Mechanism	Batteria di scarico doppio flusso 3/6 lt. con entrata acqua bassa, laterale e posteriore. Finitura cromo. Mechanism with dual flush 3/6 lt with bottom, side, and back water entry. Chrome finish.	BPCDF	-	1,65	
	Sedile Slim "soft-close" Seat & cover Slim "soft-close"	Sedile "Soft-Close" Slim in resina termoindurente. Seat & Cover "Soft-Close" Slim, in thermosetting resin.	MS86CSN11	-	2,8	
	Sedile "soft-close" Seat & cover "soft-close"	Sedile "Soft-Close" in resina termoindurente. Seat & cover "Soft-Close", of thermosetting resin.	MS86CN11	-	3,35	
	Sedile Seat & cover	Sedile in resina termoindurente. Seat & cover, of thermosetting resin.	MS86N11	-	3,35	
	Sedile Contract "soft-close" Contract seat & cover "soft-close"	Sedile "Soft-Close" in resina termoindurente. Seat & Cover "Soft-Close", in thermosetting resin.	MS99C11	-	2,4	
	Sedile Contract Contract seat & cover	Sedile in resina termoindurente. Seat & Cover, in thermosetting resin.	MS9911	-	2,4	
	Curva tecnica a S Technical curve S	Curva tecnica a S per wc e wc monoblocco, con fissaggio. Technical curve S shape for cc pans with fixing included.	MCURVAS	ø 11	0,9	
	Kit di fissaggio Fixing screw	Kit di fissaggio orizzontale per wc o bidet. Finitura cromo e bianco. Consigliato. Fixing screw horizontal for wc or bidet. Chrome finish and white. Recommended.	FVB	-	0,1	



31x39 - 769711





○ Bianco lucido
Glossy white

31x39
769711



25x36
889711



Dimensione Dimension (cm)	Componente Component	Descrizione Description	○ Cod.	Cm	Kg	269
31x39	Orinatoio Urinal	Orinatoio sospeso predisposto per fissaggio del coperchio. Wall mounted urinal prearranged for cover fixing.	○ 769711	31x39 h60	12,4	
		Orinatoio sospeso con fori per fissaggio del coperchio. Wall mounted urinal with hole for cover fixing.	○ 769811	31x39 h60	12,4	
	Coperchio Cover	Coperchio soft-close per orinatoio. Soft-close cover for urinal.	○ MSORN	-	1	
25x36	Orinatoio Urinal	Orinatoio sospeso. Wall mounted urinal.	○ 889711	25x36 h60	9,8	
	Raccordo Inlet Pipe	Raccordo entrata acqua da 1/2. Inlet pipe water entry 1/2.	RAC	1/2"	0,1	
	Sifone Siphon	Sifone con uscita orizzontale. Siphon with horizontal outlet.	SIF50	ø50	0,25	
	Kit di fissaggio Fixing screw	Kit di fissaggio Fixing screw	FCOLONNAS	-	0,1	



190x90 - VAPR90

○ Bianco lucido
Glossy white

190x90
VAPR90



Dimensione Dimension (cm)	Componente Component	Descrizione Description	○ Cod.	Cm	Kg	271
190x90	Vasca Bathtub	Vasca in acrilico completa di sifone e piletta con chiusura a scatto. Acrylic bathtub including siphon and drain with snap closure.	○ VAPR90	190x90	53	

Lavabi Washbasins

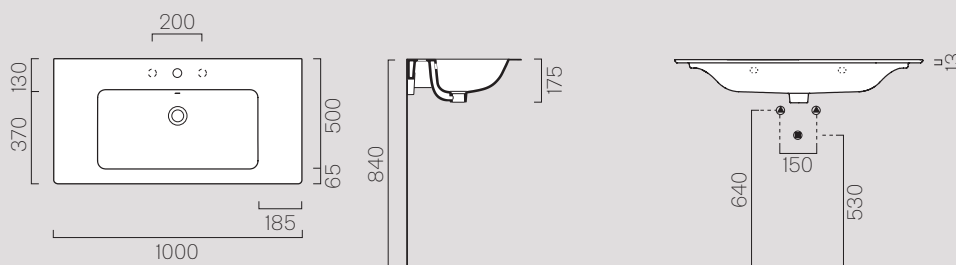

100x50
8844111

Description	Washbasin
Code	8844111
Dimensions	100x50
Weight	Kg 21
Capacity	Lt 10
Overflow	CL 25
Installation	wall-hung, built-in
Taphole	1(3)

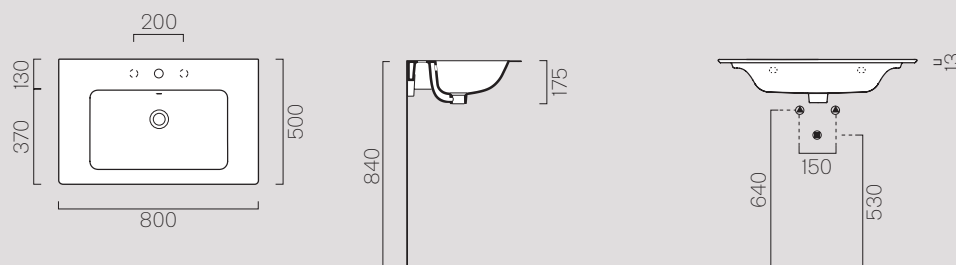

80x50
8843111

Description	Washbasin
Code	8843111
Dimensions	80x50
Overflow	CL 25
Installation	wall-hung, built-in
Taphole	1(3)

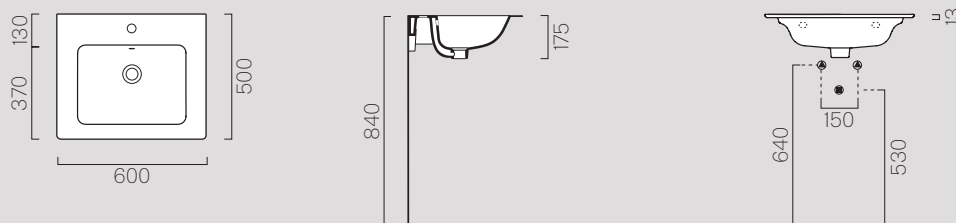

60x50
8836111

Description	Washbasin
Code	8836111
Dimensions	60x50
Overflow	CL 25
Installation	wall-hung, built-in
Taphole	1(3)

122x46

8840111

Description	Washbasin
Code	8840111
Dimensions	122x46
Weight	Kg 25
Capacity	Lt 15
Overflow	CL 25
Installation	wall-hung, built-in
Taphole	1 (5)

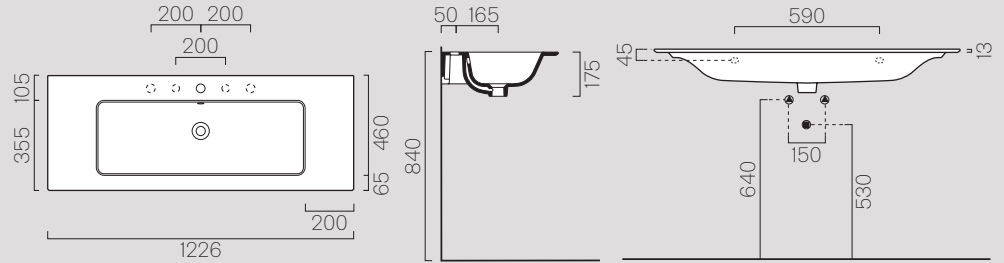

102x46

8833111

Description	Washbasin
Code	8833111
Dimensions	102x46
Weight	Kg 19,8
Capacity	Lt 9
Overflow	CL 25
Installation	wall-hung, built-in
Taphole	1 (3)

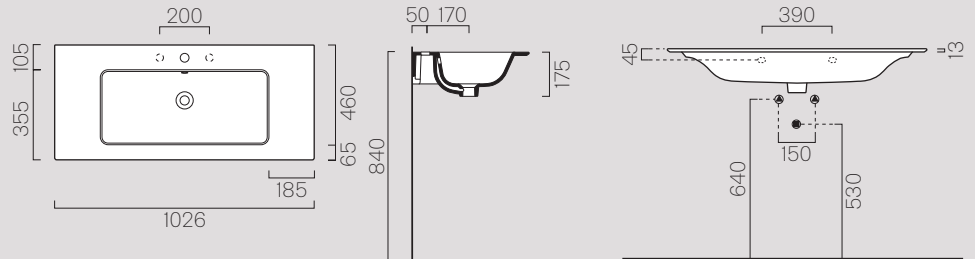

82x46

8838111

Description	Washbasin
Code	8838111
Dimensions	82x46
Weight	Kg 16
Capacity	Lt 8
Overflow	CL 25
Installation	wall-hung, built-in
Taphole	1 (3)

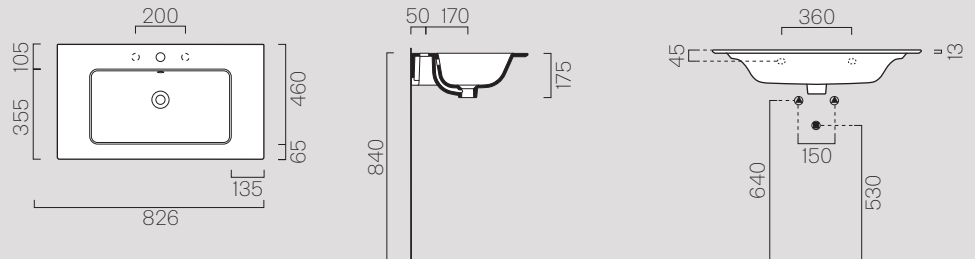

62x46

8839111

Description	Washbasin
Code	8839111
Dimensions	62x46
Overflow	CL 25
Installation	wall-hung, built-in
Taphole	1 (3)

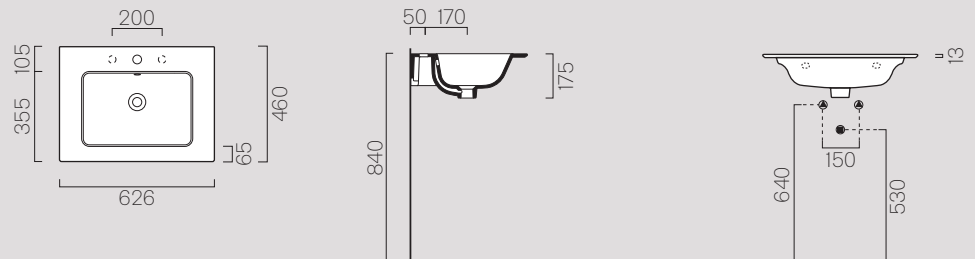

102x52

882511

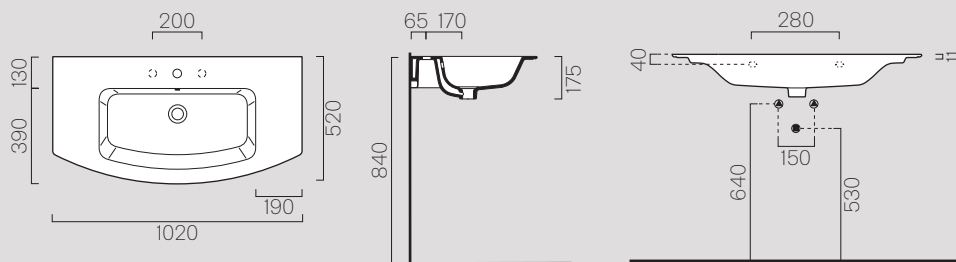

Description	Washbasin
Code	882511
Dimensions	102x52 h19
Weight	Kg 21,2
Capacity	Lt 9,5
Overflow	CL 25
Installation	wall-hung,
	built-in
Taphole	1 (3)

82x49

882611

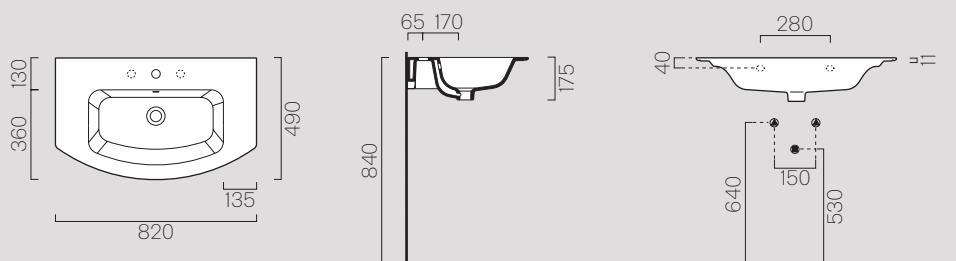

Description	Washbasin
Code	882611
Dimensions	82x49 h19
Weight	Kg 15,3
Overflow	CL 25
Installation	wall-hung,
	built-in
Taphole	1 (3)

62x48

882711

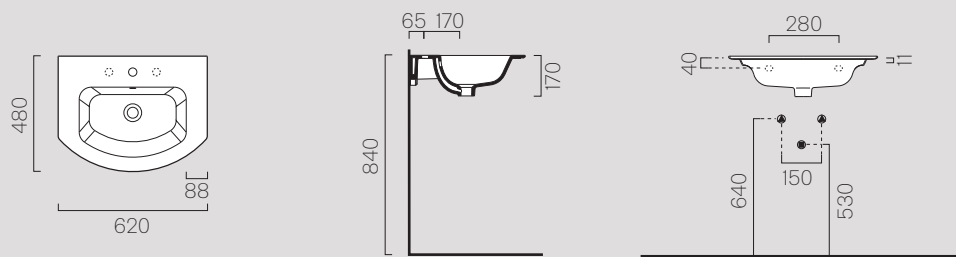

Description	Washbasin
Code	882711
Dimensions	62x48 h19
Weight	Kg 11,1
Capacity	Lt 6
Overflow	CL 25
Installation	wall-hung,
	built-in
Taphole	1 (3)

52x44

883011

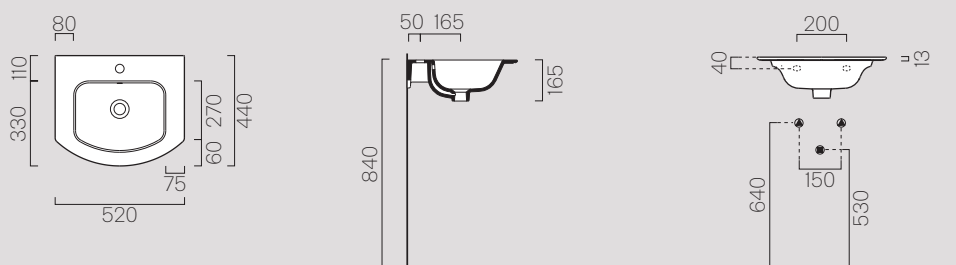

Description	Washbasin
Code	883011
Dimensions	52x44
Weight	Kg 9,2
Capacity	Lt 4
Overflow	CL 25
Installation	wall-hung,
	built-in
Taphole	1

60x42

884211

Description	Washbasin
Code	884211
Dimensions	60x42
Weight	Kg 9,9
Capacity	Lt 10
Overflow	CL 00
Installation	countertop
Taphole	0

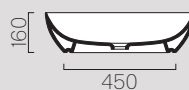
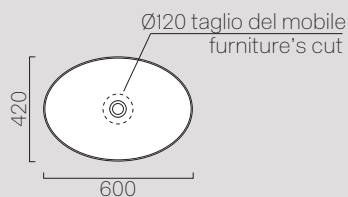

60x37

883411

Description	Washbasin
Code	883411
Dimensions	60x37
Weight	Kg 11
Capacity	Lt 9
Overflow	CL 00
Installation	countertop
Taphole	0

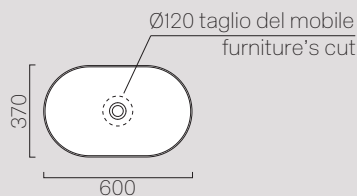

Ø42

885111

Description	Washbasin
Code	885111
Dimensions	Ø42
Weight	Kg 7,8
Capacity	Lt 7
Overflow	CL 00
Installation	countertop
Taphole	0

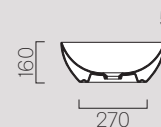
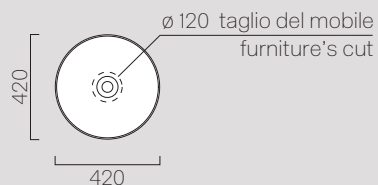

Ø42 h22

885211

Description	Washbasin
Code	885211
Dimensions	Ø42
Weight	Kg 10
Capacity	Lt 11
Overflow	CL 00
Installation	countertop
Taphole	0

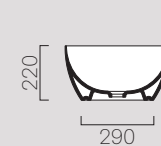
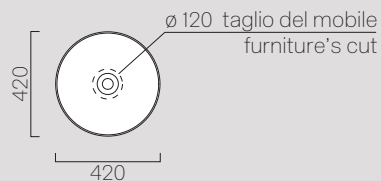

60x38 883711

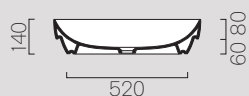
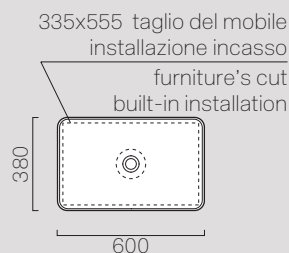

Description	Washbasin
Code	883711
Dimensions	60x38 h14
Weight	Kg 12,8
Capacity	Lt 9
Overflow	CL 00
Installation	built-in, countertop
Taphole	0

50x38 884711

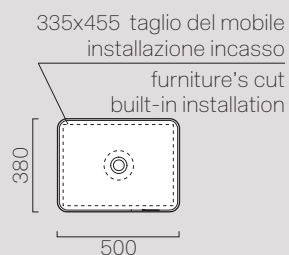

Description	Washbasin
Code	884711
Dimensions	50x38 h14
Weight	Kg 10,1
Capacity	Lt 7
Overflow	CL 00
Installation	built-in, countertop
Taphole	0

38x38 885011

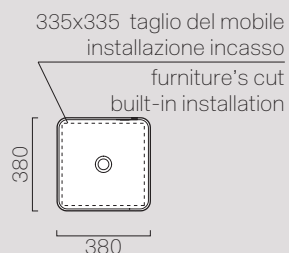

Description	Washbasin
Code	885011
Dimensions	38x38 h14
Weight	Kg 8,7
Capacity	Lt 5
Overflow	CL 00
Installation	built-in, countertop
Taphole	0

Ø40 884611

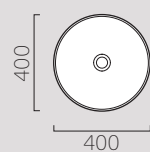

Description	Washbasin
Code	884611
Dimensions	Ø40 h14
Weight	Kg 7,5
Capacity	Lt 5
Overflow	CL 00
Installation	built-in, countertop
Taphole	0

55x38

724311

Description	Washbasin
Code	724311
Dimensions	55x38
Weight	Kg 8
Capacity	Lt 9,5
Overflow	CL 25
Installation	under-counter
Taphole	0

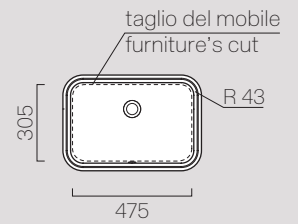
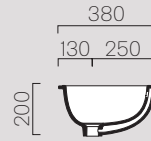
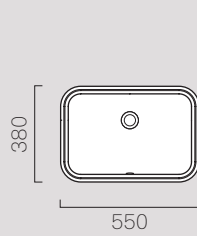

50x35

724711

Description	Washbasin
Code	724711
Dimensions	50x35
Weight	Kg 7,6
Capacity	Lt 8
Overflow	CL 25
Installation	under-counter
Taphole	0

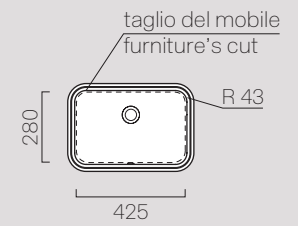
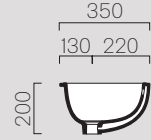
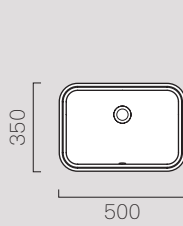

Wc e Bidet

Wc and Bidet

55x36/F

881511

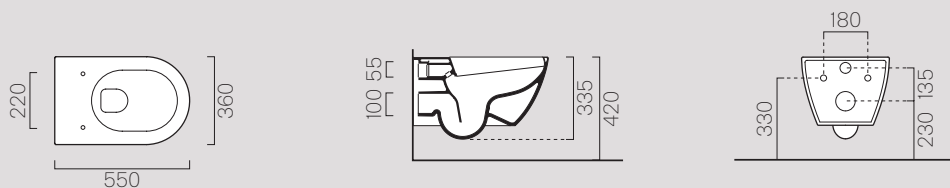

Description	Wc
Code	881511
Dimensions	55x36
Weight	Kg 18,5
Flush system	swirlflush
Installation	wall-hung

Non è consigliato l'impiego di cassette di scarico esterne o impianti dotati di rubinetto flussometro.
 We do not recommend the use of external flushing cisterns or systems endowed with flushometer valves.

55x36

881211

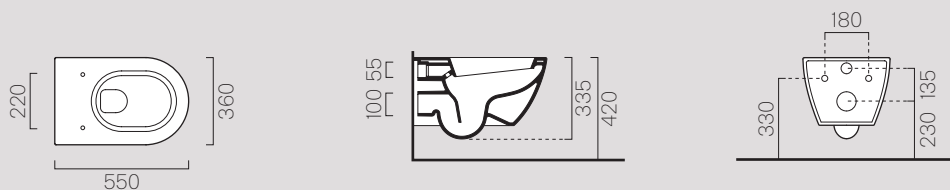

Description	Wc
Code	881211
Dimensions	55x36
Weight	Kg 23,7
Flush system	standard
Installation	wall-hung

55x36

8865111

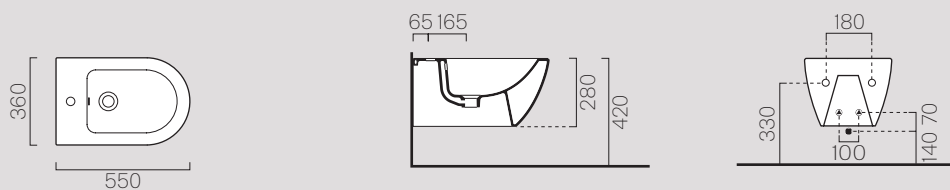

Description	Bidet
Code	8865111
Dimensions	55x36
Weight	Kg 17
Overflow	CL 25
Installation	wall-hung
Taphole	1

50x36/F

881611

Description	Wc
Code	881611
Dimensions	50x36
Weight	Kg 22,8
Flush system	swirflush
Installation	wall-hung

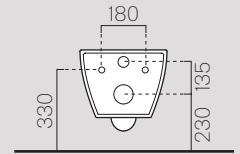
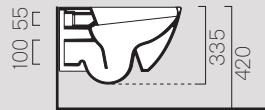
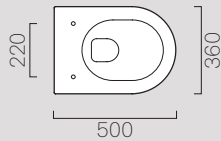

50x36

881811

Description	Wc
Code	881811
Dimensions	50x36
Weight	Kg 18,5
Flush system	standard
Installation	wall-hung

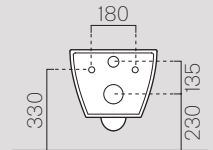
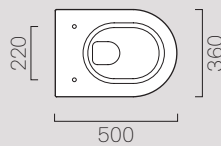

Non è consigliato l'impiego di cassette di scarico esterne o impianti dotati di rubinetto flussometro.

We do not recommend the use of external flushing cisterns or systems endowed with flushometer valves.

50x36

8864111

Description	Bidet
Code	8864111
Dimensions	50x36
Weight	Kg 16,3
Overflow	CL 25
Installation	wall-hung
Taphole	1

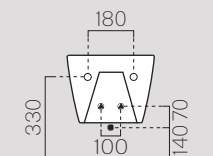
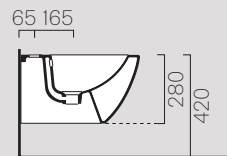
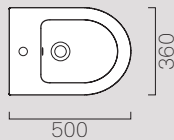

54,5x35/F

881111

Description	Wc
Code	881111
Dimensions	54,5x35
Weight	Kg 23,3
Flush system	swirflush
Installation	wall-hung

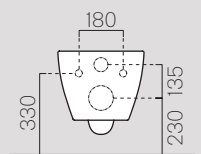
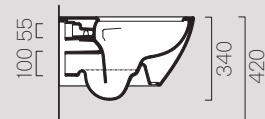
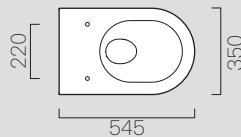

Non è consigliato l'impiego di cassette di scarico esterne o impianti dotati di rubinetto flussometro.

We do not recommend the use of external flushing cisterns or systems endowed with flushometer valves.

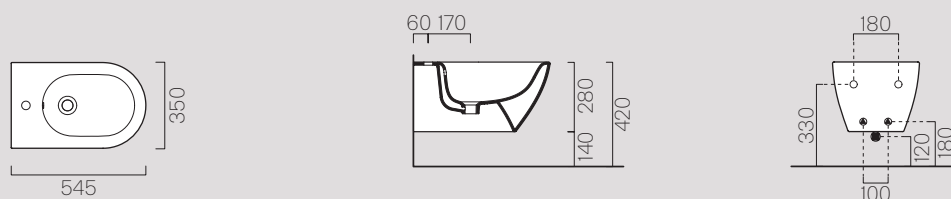
886111

Description	Bidet
Code	886111
Dimensions	54,5x35
Weight	Kg 17,1
Overflow	CL 25
Installation	wall-hung
Taphole	1

55x36/F

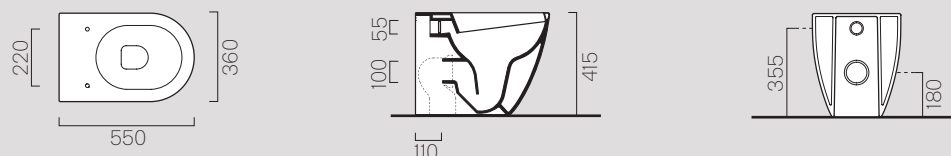
881011

Description	Wc
Code	881011
Dimensions	55x36
Weight	Kg 23,5
Flush system	swirlflush
Installation	floor-standing

Curva tecnica
Technical curve

**Codice**

Codes

MCURVA

MCURVA90

Interasse

Distance

* 110

* 70

Non è consigliato l'impiego di cassette di scarico esterne o impianti dotati di rubinetto flussometro.
We do not recommend the use of external flushing cisterns or systems endowed with flushometer valves.

55x36

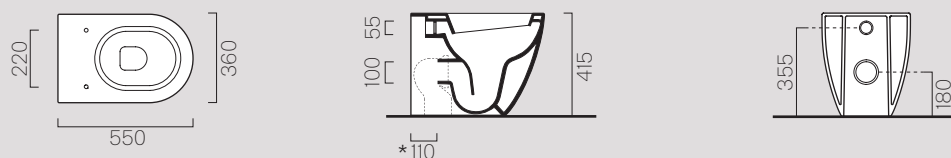
881411

Description	Wc
Code	881411
Dimensions	55x36
Weight	Kg 24,5
Flush system	standard
Installation	floor-standing

Curva tecnica
Technical curve

**Codice**

Codes

MCURVA

MCURVAS

MCURVA90

Interasse

Distance

* 110

* Da 160 a 185 mm
* From 160 to 185 mm* Da 55 a 75 mm
* From 55 to 75 mm

55x36

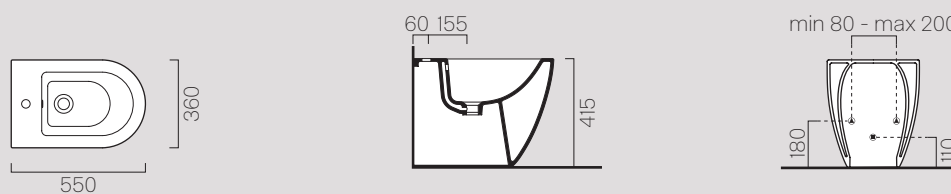
8862111

Description	Bidet
Code	8862111
Dimensions	55x36
Weight	Kg 23,1
Overflow	CL 25
Installation	floor-standing
Taphole	1

50x36/F

882011

Description	Wc
Code	882011
Dimensions	50x36
Weight	Kg 25
Flush system	swirflush
Installation	floor standing

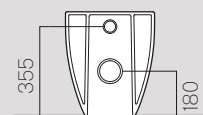
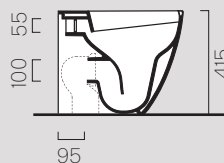
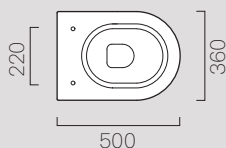

Curva tecnica
Technical curve

**Codice**

Codes

MCURVA

MCURVA90

Interasse

Distance

* 95

* 65

Non è consigliato l'impiego di cassette di scarico esterne o impianti dotati di rubinetto flussometro.
We do not recommend the use of external flushing cisterns or systems endowed with flushometer valves.

50x36

881911

Description	Wc
Code	881911
Dimensions	50x36
Weight	Kg 23,5
Flush system	standard
Installation	floor standing

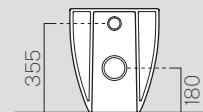
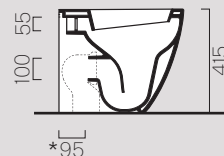
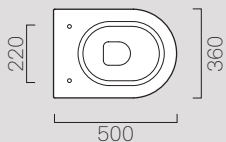

Curva tecnica
Technical curve

**Codice**

Codes

MCURVA

MCURVAS

MCURVA90

Interasse

Distance

* 95

* 165

* 70

50x36

8869111

Description	Bidet
Code	8869111
Dimensions	50x36
Weight	Kg 18
Overflow	CL 25
Installation	floor standing
Taphole	1

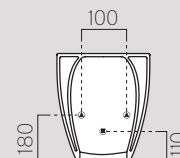
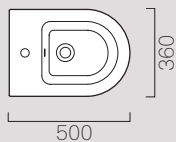

68x36

881711

Description	Wc
Code	881711
Dimensions	68x36
Weight	Kg 33,3
Flush system	standard
Installation	floor standing

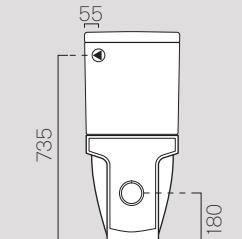
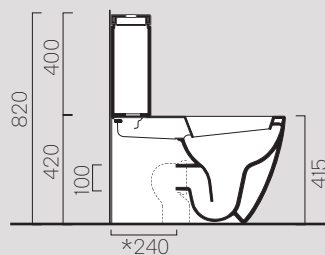
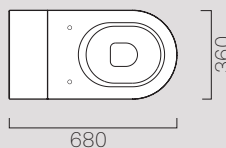

Curva tecnica
Technical curve

**Codice**

Codes

MCURVAS

MCURVA90

Interasse

Distance

* Da 230 a 305 mm
* From 230 to 305 mm* Da 80 a 205 mm
* From 80 to 205 mm

Vista dal retro.
View from the back.
Blick von hinten.

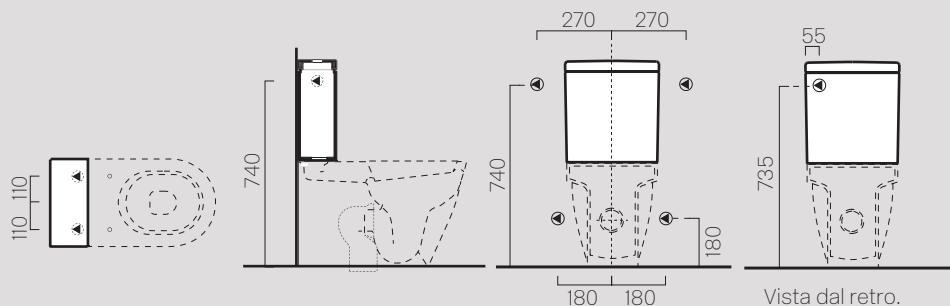

Description	Cistern
Code	868111
Dimensions	17x31 43h
Weight	Kg 13,5

Vista dal retro.
View from the back.
Blick von hinten.

Scocca
869111

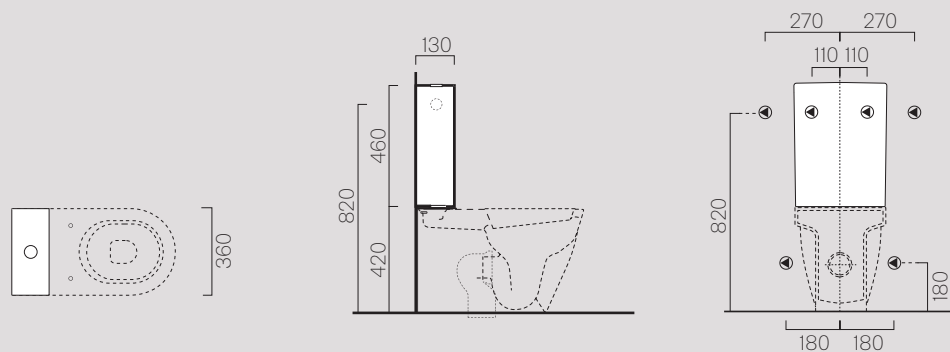

Description	Ceramic Cover
Code	869111
Dimensions	13x35,5 46h
Weight	Kg 9,6

Vista dal retro.
View from the back.
Blick von hinten.

Orinatoio

Urinal

31x39

769711

Description	Urinal
Code	769711
Dimensions	31x39 h60
Weight	Kg 12,4

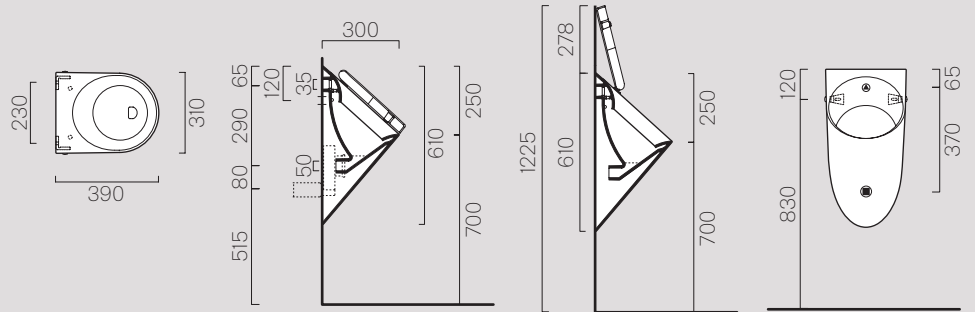

25x36

889711

Description	Urinal
Code	889711
Dimensions	25x36 h60
Weight	Kg 9,8

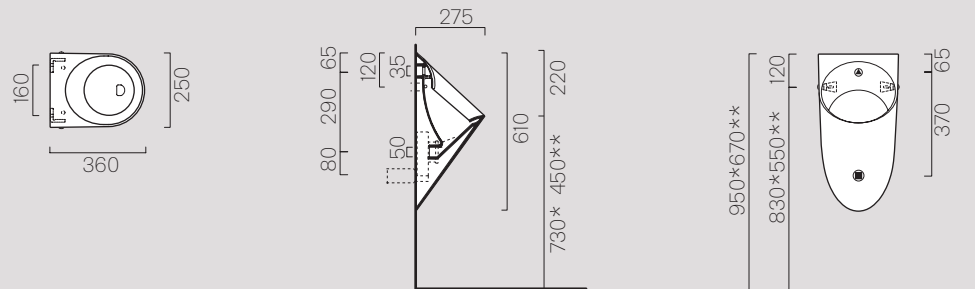

* uomo/man
** bambino/kid

Vasca Bathtub

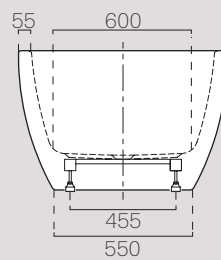
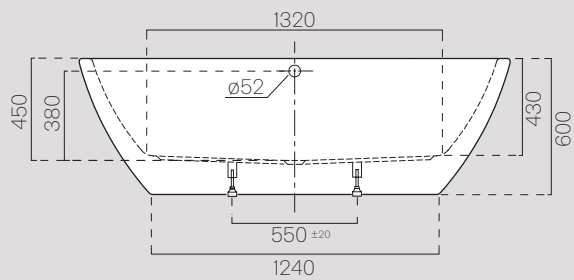
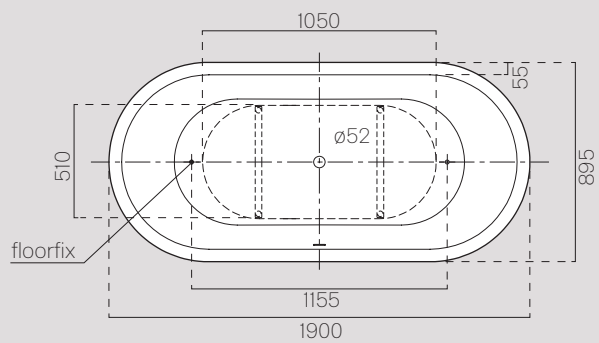

190x90
VAPR90

Description	Bathtub
Code	VAPR90
Dimensions	190x90
Weight	Kg 53
Installation	freestanding
Material	acrylic

