

# NORM



Lavabi / Washbasins	
56x40,56x40	p.162
125x50, 120x50, 100x50	p.164
90x50, 75x50, 60x50	p.166
70x40, 60x40, 50x40	p.168
42x34, 35x26	p.170
120x50, 100x50	p.172
80x50, 65x50, 50x40	p.174

Wc e Bidet / Wc and Bidet	
55x36F, 55x36	p.176
50x36F, 50x36	p.178
45x35	p.180
55x36	p.182
68x36	p.184

**Le linee semplici e regolari di Norm si declinano in un ampio spettro di misure per rispondere alle diverse esigenze di spazio e di personalizzazione. La gamma dei lavabi comprende infatti consolle di grandi dimensioni, con catino unico o doppio, fino al lavabo minimo 35x26. La predisposizione per l'abbinamento con accessori e arredi facilita la progettazione di un ambiente bagno funzionale seppure personalizzabile in ogni aspetto: i bacini capienti, la predisposizione per l'aggiunta di portasciugamani, le molteplici possibilità di installazione, e infine i diversi sistemi di arredo abbinabili, rendono Norm una collezione particolarmente performante ai fini contract. In fine, i sanitari dispongono di tutti gli speciali plus GSI.**

Norm's simple and elegant lines come in a wide range of sizes to meet a variety of needs for space and personalization. The set of washbasins start from large single or twin basin consoles down to the smallest 35x25 hand rinse basin. Designed to be combined with accessories and furnishings, they make it easy to plan a functional bathroom environment that can be customized in every detail: capacious washbasins, the possibility to add towel racks, the many installation options and finally the different combinable furnishing systems make Norm a high performance collection ideal for subcontracting. Finally, the sanitary elements all come with GSI's special extras.

# Norm

# Lavabi

## Washbasins

56x40  
**75590PF11**  
**75580PF11**  
 p.162



56x40  
**75571PF11**  
**75561PF11**  
 p.162



125x50  
**8625111**  
 p.164



120x50  
**8624111**  
 p.164



100x50  
**8623111**  
 p.164



90x50  
**8688111**  
 p.166



75x50  
**8687111**  
 p.166



60x50  
**8683111**  
 p.166



70x40  
**8632111**  
 p.168



60x40  
**8631111**  
 p.168



50x40  
**8630111**  
 p.168



42x34  
**8684111**  
 p.170



35x26  
**8650111**  
 p.170



# Wc e Bidet

## Wc and Bidet

120x50  
**7724111**  
p.172



100x50  
**7723111**  
p.172



80x50  
**7722111**  
p.174



65x50  
**7732111**  
p.174



50x40  
**7785111**  
p.174



55x36/F  
**861511**  
p.176



55x36  
**861211**  
**8665111**  
p.176



50x36/F  
**861611**  
p.178



50x36  
**861811**  
**8664111**  
p.178



45x35  
**861011**  
p.180



55x36  
**861411**  
**8662111**  
p.182



68x36  
**861711**  
p.184





56x40 - 75571PF11

○ Bianco lucido  
Glossy white

56x40  
**75590PF11**  
**75580PF11**



56x40  
**75571PF11**  
**75561PF11**



56x40

**Element Free  
scarico a parete**  
**Element Free  
wall discharge**Lavabo senza foro troppopieno, predisposto per rubinetteria da parete o pavimento. Installazione con scarico a parete (fissaggio incluso).  
Washbasin with no overflow, prearranged for wall or floor tap fitting. Installation with wall discharge (fixing screw included).

75590PF11

56x40 h85

47,2

**Piletta  
Drain**Piletta con apertura fissa. Finitura cromo (consigliato).  
Drain with standard opening. Chrome finish (recommended).

PILLV

1" 1/4

0,4

**Piletta in Ceramica  
Ceramic Drain**Piletta con apertura fissa per lavabo senza foro troppopieno, corpo in ottone e coperchio in ceramica.  
Drain with standard opening for basin with no overflow, brass body and ceramic cover plate.

PVC11

-

0,65

**Sifone  
Siphon**Sifone tondo in ottone cromato per lavabo con scarico a parete.  
Siphon round, of chromed brass, for wall discharge basin.

MMBSIF

1" 1/4

1,3

**Element Free  
scarico a pavimento**  
**Element Free  
floor discharge**Lavabo senza foro troppopieno, predisposto per rubinetteria da parete o pavimento. Installazione a centro stanza con scarico a pavimento (fissaggio incluso).  
Washbasin with no overflow, prearranged for wall or floor tap fitting. Installation at room centre with floor discharge (fixing screw included).

75580PF11

56x40 h85

47,2

**Sifone  
Siphon**Sifone con piletta con apertura fissa in ottone cromato, per lavabo con scarico a pavimento.  
Siphon with standard opening drain in chromed brass, for floor outlet basin.

SIFSP

-

0,9

56x40

**Element Free  
scarico a parete**  
**Element Free  
wall discharge**Lavabo con foro troppopieno monoforo. Installazione con scarico a parete (fissaggio incluso).  
Washbasin with overflow one taphole. Installation with wall discharge (fixing screw included).

75571PF11

56x40 h85

49

**Piletta  
Drain**Piletta con chiusura a scatto. Finitura cromo.  
Drain with snap closure. Chrome finish.

PILL

1" 1/4

0,45

**Piletta in Ceramica  
Ceramic Drain**Piletta con chiusura a scatto per lavabo con foro troppopieno, corpo in ottone e coperchio in ceramica.  
Drain with snap closure for basin with overflow, brass body and ceramic cover plate.

PCS11

-

0,65

**Sifone  
Siphon**Sifone tondo in ottone cromato per lavabo con scarico a parete.  
Siphon round, of chromed brass, for wall discharge basin.

MMBSIF

1" 1/4

1,3

**Element Free  
scarico a pavimento**  
**Element Free  
floor discharge**Lavabo con foro troppopieno monoforo. Installazione a centro stanza con scarico a pavimento (fissaggio incluso).  
Washbasin with overflow one taphole. Installation at room centre with floor discharge (fixing screw included).

75561PF11

56x40 h85

49

**Sifone  
Siphon**Sifone con piletta con chiusura a scatto in ottone cromato, per lavabo con scarico a pavimento.  
Siphon with snap closure drain in chromed brass, for floor outlet basin.

SIFCP

-

0,9

**Placca di chiusura  
Chromed plate**Placca cromata per copertura del foro troppopieno.  
Chromed plate for overflow covering.

PCT

-

0,05



100x50 - 8623111



125x50 - 8625111

○ Bianco lucido  
Glossy white

125x50  
**8625111**









120x50  
**8624111**



100x50  
**8623111**





Dimensione Dimension (cm)	Componente Component	Descrizione Description	○ Cod.	Cm	Kg	165
125x50	<b>Lavabo Washbasin</b>	Lavabo con foro troppopieno monoforo predisposto per rubinetteria triforo. Installazione a sospensione e incasso. Washbasin with overflow one taphole, prearranged for three taphole fittings. Wall-hung, built-in installation.	○ 8625111	125x50 h18	34,8	
	<b>Portasciugamani Towel rail</b>	Portasciugamani quadro in metallo cromato. Towel rail square in chromed metal.	PAFL120	-	0,9	
	<b>Portasciugamani Towel rail</b>	Portasciugamani quadro in metallo cromato. (2 pezzi) Towel rail square in chromed metal. (2 pieces)	PAFL261	-	1,4	
	<b>Kit di fissaggio Fixing kit</b>	Kit fissaggio per lavabo sospeso (2 kit obbligatori). Fixing kit for wall-hung washbasin (2 kits required).	FLAVABO	-	0,2	
120x50	<b>Lavabo Washbasin</b>	Lavabo con foro troppopieno monoforo predisposto per rubinetteria cinque fori. Installazione a sospensione e incasso. Washbasin with overflow one taphole, prearranged for five taphole fittings. Wall-hung, Built-in installation.	○ 8624111	120x50 h18	30	
	<b>Portasciugamani Towel rail</b>	Portasciugamani quadro in metallo cromato. Towel rail square in chromed metal.	PAFL120	-	0,9	
		<b>Kit di fissaggio Fixing kit</b>	Kit fissaggio per lavabo sospeso (2 kit obbligatori). Fixing kit for wall-hung washbasin (2 kits required).	FLAVABO	-	0,2
100x50	<b>Lavabo Washbasin</b>	Lavabo con foro troppopieno monoforo predisposto per rubinetteria triforo. Installazione a sospensione e incasso. Washbasin with overflow one taphole, prearranged for three taphole fittings. Wall-hung, Built-in installation.	○ 8623111	100x50 h18	26	
	<b>Portasciugamani Towel rail</b>	Portasciugamani quadro in metallo cromato. Towel rail square in chromed metal.	PAKQ100	-	0,9	
		<b>Kit di fissaggio Fixing kit</b>	Kit fissaggio per lavabo sospeso (obbligatorio). Fixing kit for wall-hung washbasin (required).	FLAVABO	-	0,2
	<b>Piletta Drain</b>	Piletta con chiusura a scatto. Finitura cromo. Drain with snap closure. Chrome finish.	PILL	1" 1/4	0,45	
	<b>Piletta in Ceramica Ceramic Drain</b>	Piletta con chiusura a scatto per lavabo con foro troppopieno, corpo in ottone e coperchio in ceramica. Drain with snap closure for basin with overflow, brass body and ceramic cover plate.	PCS11	-	0,65	
	<b>Sifone Siphon</b>	Sifone tondo in ottone cromato. Siphon round, of chromed brass.	MMBSIF	1" 1/4	1,3	
		Sifone tondo in abs cromato. Siphon round, in chromed abs.	MMBSIFC	1" 1/4	0,3	
	<b>Placca di chiusura Chromed plate</b>	Placca cromata per copertura del foro troppopieno. Chromed plate for overflow covering.	PCT	-	0,05	



75x50 - 8687111

○ Bianco lucido  
Glossy white

90x50  
**8688111**



75x50  
**8687111**



60x50  
**8683111**



Dimensione Dimension (cm)	Componente Component	Descrizione Description	○ Cod.	Cm	Kg	167
90x50	<b>Lavabo Washbasin</b>	Lavabo con foro troppopieno monoforo predisposto per rubinetteria triforo. Installazione a sospensione e incasso. Washbasin with overflow one taphole, prearranged for three taphole fittings. Wall-hung, built-in installation.	○ 8688111	90x50 h18	24,6	
	<b>Portasciugamani Towel rail</b>	Portasciugamani quadro in metallo cromato. Towel rail square in chromed metal.	PAFL90	-	0,85	
75x50	<b>Lavabo Washbasin</b>	Lavabo con foro troppopieno monoforo predisposto per rubinetteria triforo. Installazione a sospensione e incasso. Washbasin with overflow one taphole, prearranged for three taphole fittings. Wall-hung, built-in installation.	○ 8687111	75x50 h18	20,1	
	<b>Portasciugamani Towel rail</b>	Portasciugamani quadro in metallo cromato. Towel rail square in chromed metal.	PASQ75	-	0,7	
60x50	<b>Lavabo Washbasin</b>	Lavabo con foro troppopieno monoforo predisposto per rubinetteria triforo. Installazione a sospensione e incasso. Washbasin with overflow one taphole, prearranged for three taphole fittings. Wall-hung, built-in installation.	○ 8683111	60x50 h18	18,1	
	<b>Portasciugamani Towel rail</b>	Portasciugamani quadro in metallo cromato. Towel rail square in chromed metal.	PAFL61	-	0,7	
	<b>Piletta Drain</b>	Piletta con chiusura a scatto. Finitura cromo. Drain with snap closure. Chrome finish.	PILL	1" 1/4	0,45	
	<b>Piletta in Ceramica Ceramic Drain</b>	Piletta con chiusura a scatto per lavabo con foro troppopieno, corpo in ottone e coperchio in ceramica. Drain with snap closure for basin with overflow, brass body and ceramic cover plate.	PCS11	-	0,65	
	<b>Sifone Siphon</b>	Sifone tondo in ottone cromato. Siphon round, of chromed brass.	MMBSIF	1" 1/4	1,3	
		Sifone tondo in abs cromato. Siphon round, in chromed abs.	MMBSIFC	1" 1/4	0,3	
	<b>Placca di chiusura Chromed plate</b>	Placca cromata per copertura del foro troppopieno. Chromed plate for overflow covering.	PCT	-	0,05	
	<b>Kit di fissaggio Fixing kit</b>	Kit fissaggio per lavabo sospeso (obbligatorio). Fixing kit for wall-hung washbasin (required).	FLAVABO	-	0,2	



50x40 - 8630111

○ Bianco lucido  
Glossy white

70x40  
**8632111**







60x40  
**8631111**



50x40  
**8630111**



Dimensione Dimension (cm)	Componente Component	Descrizione Description	○ Cod.	Cm	Kg
70x40	<b>Lavabo</b> <b>Washbasin</b>	Lavabo con foro troppopieno monoforo. Installazione a sospensione e incasso. Washbasin with overflow one taphole. Wall-hung, built-in installation.	○ 8632111	70x40	15,3
	<b>Portasciugamani</b> <b>Towel rail</b>	Portasciugamani quadro in metallo cromato. Towel rail square in chromed metal.	PANMQ70	-	0,85
60x40	<b>Lavabo</b> <b>Washbasin</b>	Lavabo con foro troppopieno monoforo. Installazione a sospensione e incasso. Washbasin with overflow one taphole. Wall-hung, built-in installation.	○ 8631111	60x40	12,5
	<b>Portasciugamani</b> <b>Towel rail</b>	Portasciugamani quadro in metallo cromato. Towel rail square in chromed metal.	PAFL61	-	0,7
50x40	<b>Lavabo</b> <b>Washbasin</b>	Lavabo con foro troppopieno monoforo. Installazione a sospensione e incasso. Washbasin with overflow one taphole. Wall-hung, built-in installation.	○ 8630111	50x40	10,5
	<b>Portasciugamani</b> <b>Towel rail</b>	Portasciugamani quadro in metallo cromato. Towel rail square in chromed metal.	PAFL51	-	0,7
	<b>Piletta</b> <b>Drain</b>	Piletta con chiusura a scatto. Finitura cromo. Drain with snap closure. Chrome finish.	PILL	1" 1/4	0,45
	<b>Piletta in Ceramica</b> <b>Ceramic Drain</b>	Piletta con chiusura a scatto per lavabo con foro troppopieno, corpo in ottone e coperchio in ceramica. Drain with snap closure for basin with overflow, brass body and ceramic cover plate.	PCS11	-	0,65
	<b>Sifone</b> <b>Siphon</b>	Sifone tondo in ottone cromato. Siphon round, of chromed brass.	MMBSIF	1" 1/4	1,3
		Sifone tondo in abs cromato. Siphon round, in chromed abs.	MMBSIFC	1" 1/4	0,3
	<b>Placca di chiusura</b> <b>Chromed plate</b>	Placca cromata per copertura del foro troppopieno. Chromed plate for overflow covering.	PCT	-	0,05
	<b>Kit di fissaggio</b> <b>Fixing kit</b>	Kit fissaggio per lavabo sospeso (obbligatorio). Fixing kit for wall-hung washbasin (required).	FLAVABO	-	0,2



35x26 - 8650111

○ Bianco lucido  
Glossy white

42x34  
**8684111**



35x26  
**8650111**



Dimensione Dimension (cm)	<b>Componente</b> <b>Component</b>	Descrizione Description	○ Cod.	Cm	Kg	
42x34	<b>Lavabo</b> <b>Washbasin</b>	Lavabo con foro troppopieno monoforo. Installazione a sospensione e incasso. Washbasin with overflow one taphole. Wall-hung, built-in installation.	○ 8684111	42x34 h17	9,1	
	<b>Portasciugamani</b> <b>Towel rail</b>	Portasciugamani quadro in metallo cromato. Towel rail square in chromed metal.	PATQ40	-	0,5	
	 <b>Piletta</b> <b>Drain</b>	Piletta con chiusura a scatto. Finitura cromo. Drain with snap closure. Chrome finish.	PILL	1" 1/4	0,45	
	 <b>Piletta in Ceramica</b> <b>Ceramic Drain</b>	Piletta con chiusura a scatto per lavabo con foro troppopieno, corpo in ottone e coperchio in ceramica. Drain with snap closure for basin with overflow, brass body and ceramic cover plate.	PCS11	-	0,65	
	<b>Placca di chiusura</b> <b>Chromed plate</b>	Placca cromata per copertura del foro troppopieno. Chromed plate for overflow covering.	PCT	-	0,05	
35x26	<b>Lavabo</b> <b>Washbasin</b>	Lavabo senza foro troppopieno monoforo. Installazione a sospensione e incasso. Washbasin with no overflow one taphole. Wall-hung, built-in installation.	○ 8650111	35x26 h12	5,6	
	 <b>Piletta</b> <b>Drain</b>	Piletta con apertura fissa. Finitura cromo. Drain with standard opening. Chrome finish.	PILLV	1" 1/4	0,45	
	 <b>Piletta in Ceramica</b> <b>Ceramic Drain</b>	Piletta con apertura fissa per lavabo senza foro troppopieno, corpo in ottone e coperchio in ceramica. Drain with standard opening for basin with no overflow, brass body and ceramic cover plate.	PVC11	-	0,65	
		<b>Sifone</b> <b>Siphon</b>	Sifone tondo in ottone cromato. Siphon round, of chromed brass.	MMBSIF	1" 1/4	1,3
			Sifone tondo in abs cromato. Siphon round, in chromed abs.	MMBSIFC	1" 1/4	0,3
	<b>Kit di fissaggio</b> <b>Fixing kit</b>	Kit fissaggio per lavabo sospeso (obbligatorio). Fixing kit for wall-hung washbasin (required).	FLAVABO	-	0,2	



100x50 - 7723111



120x50 - 7724111

○ Bianco lucido  
Glossy white





120x50  
**7724111**



100x50  
**7723111**





Dimensione Dimension (cm)	Componente Component	Descrizione Description	○ Cod.	Cm	Kg
120x50	<b>Lavabo Washbasin</b>	Lavabo con foro troppopieno monoforo, predisposto per rubinetteria triforo. Installazione a sospensione o ad incasso. Washbasin with overflow, one taphole prearranged for three taphole fittings. Wall-hung or built-in installation.	○ 7724111	120x50 h18	29
	<b>Portasciugamani Towel rail</b>	Portasciugamani quadro 120 in metallo cromato. Towel rail square 120, in chromed metal.	PAMQ120	-	0,9
100x50	<b>Lavabo Washbasin</b>	Lavabo con foro troppopieno monoforo, predisposto per rubinetteria triforo. Installazione a sospensione o ad incasso. Washbasin with overflow, one taphole prearranged for three taphole fittings. Wall-hung or built-in installation.	○ 7723111	100x50 h18	24,6
	<b>Portasciugamani Towel rail</b>	Portasciugamani quadro 100 in metallo cromato. Towel rail square 100, in chromed metal.	PAMQ100	-	0,9
	<b>Piletta Drain</b>	Piletta con chiusura a scatto. Finitura cromo. Drain with snap closure. Chrome finish.	PILL	1" 1/4	0,45
	<b>Piletta in Ceramica Ceramic Drain</b>	Piletta con chiusura a scatto per lavabo con foro troppopieno, corpo in ottone e coperchio in ceramica. Drain with snap closure for basin with overflow, brass body and ceramic cover plate.	PCS11	-	0,65
	<b>Sifone Siphon</b>	Sifone tondo in ottone cromato. Siphon round, in chromed brass.	MMBSIF	1" 1/4	1,3
		Sifone tondo in abs cromato. Siphon round, in chromed abs.	MMBSIFC	1" 1/4	0,3
	<b>Placca di chiusura Chromed plate</b>	Placca cromata per copertura del foro troppopieno. Chromed plate for overflow covering.	PCT	-	0,05
	<b>Kit di fissaggio Fixing kit</b>	Kit fissaggio per lavabo sospeso (2 kit obbligatori). Fixing kit for wall-hung washbasin (2 kits required).	FLAVABO	-	0,2



65x50 - 7732111

○ Bianco lucido  
Glossy white

80x50  
**7722111**







65x50  
**7732111**



50x40  
**7785111**



Dimensione Dimension (cm)	Componente Component	Descrizione Description	○ Cod.	Cm	Kg
80x50	<b>Lavabo Washbasin</b>	Lavabo con foro troppopieno monoforo, predisposto per rubinetteria triforo. Installazione a sospensione o ad incasso. Washbasin with overflow, one taphole prearranged for three taphole fittings. Wall-hung or built-in installation.	○ 7722111	80x50 h18	21,1
	<b>Portasciugamani Towel rail</b>	Portasciugamani quadro 80 in metallo cromato. Towel rail square 80 in chromed metal.	PAMQ80	-	0,8
65x50	<b>Lavabo Washbasin</b>	Lavabo con foro troppopieno monoforo, predisposto per rubinetteria triforo. Installazione a sospensione o ad incasso. Washbasin with overflow, one taphole prearranged for three taphole fittings. Wall-hung or built-in installation.	○ 7732111	65x50 h18	20,1
	<b>Portasciugamani Towel rail</b>	Portasciugamani quadro 65 in metallo cromato. Towel rail square 65 in chromed metal.	PAMQ65	-	0,7
50x40	<b>Lavabo Washbasin</b>	Lavabo con foro troppopieno monoforo. Installazione a sospensione o ad incasso. Washbasin with overflow, one taphole. Wall-hung or built-in installation.	○ 7785111	50x40 h18	11,4
	<b>Portasciugamani Towel rail</b>	Portasciugamani quadro 50 in metallo cromato. Towel rail square 50 in chromed metal.	PAFL50	-	0,6
	<b>Piletta Drain</b>	Piletta con chiusura a scatto. Finitura cromo. Drain with snap closure. Chrome finish.	PILL	1" 1/4	0,45
	<b>Piletta in Ceramica Ceramic Drain</b>	Piletta con chiusura a scatto per lavabo con foro troppopieno, corpo in ottone e coperchio in ceramica. Drain with snap closure for basin with overflow, brass body and ceramic cover plate.	PCS11	-	0,65
	<b>Sifone Siphon</b>	Sifone tondo in ottone cromato. Siphon round, in chromed brass.	MMBSIF	1" 1/4	1,3
		Sifone tondo in abs cromato. Siphon round, in chromed abs.	MMBSIFC	1" 1/4	0,3
	<b>Placca di chiusura Chromed plate</b>	Placca cromata per copertura del foro troppopieno. Chromed plate for overflow covering.	PCT	-	0,05
	<b>Kit di fissaggio Fixing kit</b>	Kit fissaggio per lavabo sospeso (obbligatorio). Fixing kit for wall-hung washbasin (required).	FLAVABO	-	0,2



55x36/F - 861511



55x36 - 861211 - 8665111

○ Bianco lucido  
Glossy white

55x36/F  
**861511**  
**8665111**



55x36  
**861211**  
**8665111**



Solo per  
Only for  
861511



swirlflush®



extraglaze®



save water











quickrelease



softclose

Solo per  
Only for  
861211

55x36/F	<b>Wc sospeso</b> <b>Wall-hung wc</b>	* Wc installazione a sospensione con sistema di scarico <b>Swirflush®</b> . Wall-hung wc with <b>Swirflush®</b> system.	○ 861511	55x36	23,7
55x36	<b>Wc sospeso</b> <b>Wall-hung wc</b>	Wc installazione a sospensione con sistema di fissaggio dal basso. Wall-hung wc installation with concealed fixing.	○ 861211	55x36	24
	<b>Bidet sospeso</b> <b>Wall-hung bidet</b>	Bidet sospeso monoforo con foro troppopieno e sistema di fissaggio dal basso. Single hole wall-hung bidet with overflow and concealed fixing.	○ 8665111	55x36	16,3
	<b>Sedile Slim "soft-close"</b> <b>Seat &amp; cover Slim "soft-close"</b>	Sedile "Soft-Close" Slim in resina termoindurente. Seat & Cover "Soft-Close" Slim, in thermosetting resin.	MS86CSN11	-	2,8
	<b>Sedile "soft-close"</b> <b>Seat &amp; cover "soft-close"</b>	Sedile "Soft-Close" in resina termoindurente. Seat & Cover "Soft-Close", in thermosetting resin.	MS86CN11	-	3,3
	<b>Sedile</b> <b>Seat &amp; cover</b>	Sedile in resina termoindurente. Seat & Cover, in thermosetting resin.	MS86N11	-	3,3
	<b>Piletta</b> <b>Drain</b>	Piletta con chiusura a scatto. Finitura cromo. Drain with snap closure. Chrome finish.	PILL	1" 1/4	0,45
	<b>Piletta in Ceramica</b> <b>Ceramic Drain</b>	Piletta con chiusura a scatto per lavabo con foro troppopieno, corpo in ottone e coperchio in ceramica. Drain with snap closure for basin with overflow, brass body and ceramic cover plate.	PCS11	-	0,65
	<b>Protezione</b> <b>Protection</b>	Protezione insonorizzante per wc o bidet sospeso. Soundproof protection for wall-hung wc or bidet.	MPR	-	-
	<b>Staffe di fissaggio</b> <b>Fixing brackets</b>	Staffe di fissaggio per wc o bidet. Fixing brackets for wc or bidet.	FSOSP	-	3,8
	<b>Placca di chiusura</b> <b>Chromed plate</b>	Placca cromata per copertura del foro troppopieno. Chromed plate for overflow covering.	PCT	-	0,05
	<b>Fissaggio rapido</b> <b>Quick fixing screw</b>	Fissaggio a scomparsa dal basso (obbligatorio 1 kit per articolo) Concealed fixing (1 kit required per article)	FISR2	-	0,3

\*Non è consigliato l'impiego di cassette di scarico esterne o impianti dotati di rubinetto flussometro.  
We do not recommend the use of external flushing cisterns or systems endowed with flushometer valves.



50x36 - 861811 - 8664111

○ Bianco lucido  
Glossy white

50x36/F  
**861611**  
**8664111**

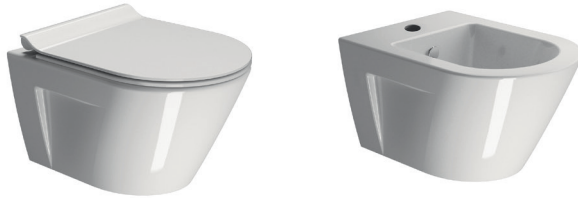

50x36  
**861811**  
**8664111**



Solo per  
Only for  
861611



**swirlflush®**



**extraglaze®**



**save water**









**quickrelease**



**softclose**

Solo per  
Only for  
861811

Dimensione Dimension (cm)	<b>Componente</b> <b>Component</b>	Descrizione Description	○ Cod.	Cm	Kg
50x36/F	<b>Wc sospeso</b> <b>Wall-hung wc</b>	* Wc installazione a sospensione con sistema di scarico <b>Swirlflush®</b> . Wall-hung wc with <b>Swirlflush®</b> system.	○ 861611	50x36	22,3
50x36	<b>Wc sospeso</b> <b>Wall-hung wc</b>	Wc installazione a sospensione con sistema di fissaggio dal basso. Wall-hung wc installation with concealed fixing.	○ 861811	50x36	16,5
	<b>Bidet sospeso</b> <b>Wall-hung bidet</b>	Bidet sospeso monoforo con foro troppopieno e sistema di fissaggio dal basso. Single hole wall-hung bidet with overflow and concealed fixing.	○ 8664111	50x36	15,3
	<b>Sedile "soft-close"</b> <b>Seat &amp; cover Slim "soft-close"</b>	Sedile "Soft-Close" Slim in resina termoindurente. Seat & Cover "Soft-Close" Slim, in thermosetting resin.	MS86CSN11	-	2,8
	<b>Sedile "soft-close"</b> <b>Seat &amp; cover "soft-close"</b>	Sedile "Soft-Close" in resina termoindurente. Seat & Cover "Soft-Close", in thermosetting resin.	MS86CN11	-	3,3
	<b>Sedile</b> <b>Seat &amp; cover</b>	Sedile in resina termoindurente. Seat & Cover, in thermosetting resin.	MS86N11	-	3,3
	<b>Piletta</b> <b>Drain</b>	Piletta con chiusura a scatto. Finitura cromo. Drain with snap closure. Chrome finish.	PILL	1" 1/4	0,45
	<b>Piletta in Ceramica</b> <b>Ceramic Drain</b>	Piletta con chiusura a scatto per lavabo con foro troppopieno, corpo in ottone e coperchio in ceramica. Drain with snap closure for basin with overflow, brass body and ceramic cover plate.	PCS11	-	0,65
	<b>Protezione</b> <b>Protection</b>	Protezione insonorizzante per wc o bidet sospeso. Soundproof protection for wall-hung wc or bidet.	MPR	-	-
	<b>Staffe di fissaggio</b> <b>Fixing brackets</b>	Staffe di fissaggio per wc o bidet. Fixing brackets for wc or bidet.	FSOSP	-	3,8
	<b>Placca di chiusura</b> <b>Chromed plate</b>	Placca cromata per copertura del foro troppopieno. Chromed plate for overflow covering.	PCT	-	0,05
	<b>Fissaggio rapido</b> <b>Quick fixing screw</b>	Fissaggio a scomparsa dal basso (obbligatorio 1 kit per articolo) Concealed fixing (1 kit required per article)	FISR2	-	0,3

\*Non è consigliato l'impiego di cassette di scarico esterne o impianti dotati di rubinetto flussometro.  
We do not recommend the use of external flushing cisterns or systems endowed with flushometer valves.



45x35 - 861011

Bianco lucido  
Glossy white

45x35  
**861011**



  
extraglaze®

  
save water

  
quickrelease

  
softclose



Dimensione Dimension (cm)	Componente Component	Descrizione Description	○ Cod.	Cm	Kg	181
45x35	<b>Wc sospeso</b> <b>Wall-hung wc</b>	Wc installazione a sospensione con sistema di fissaggio dal basso. Wall-hung wc installation with concealed fixing.	○ 861011	45x35	18,6	
	<b>Sedile Slim</b> <b>"soft-close"</b> <b>Seat &amp; cover Slim</b> <b>"soft-close"</b>	Sedile "Soft-Close" Slim in resina termoindurente. Seat & Cover "Soft-Close" Slim, in thermosetting resin.	MS76SNI1	-	3	
	<b>Protezione</b> <b>Protection</b>	Protezione insonorizzante per wc o bidet sospeso. Soundproof protection for wall-hung wc or bidet.	MPR	-	-	
	<b>Staffe di fissaggio</b> <b>Fixing brackets</b>	Staffe di fissaggio per wc o bidet. Fixing brackets for wc or bidet.	FSOSP	-	3,8	
	<b>Fissaggio rapido</b> <b>Quick fixing screw</b>	Fissaggio a scomparsa dal basso (obbligatorio 1 kit per articolo) Concealed fixing (1 kit required per article)	FISR2	-	0,3	



55x36 - 861411 - 8662111

○ Bianco lucido  
Glossy white

55x36  
**861411**  
**8662111**



extraglaze®



save water



quickrelease



softclose

Dimensione Dimension (cm)	<b>Componente</b> <b>Component</b>	Descrizione Description	○ Cod.	Cm	Kg
55x36	<b>Wc</b> <b>Wc</b>	Wc predisposto per scarico a parete oppure a pavimento tramite curva tecnica. Wall wc with or floor outlet (through pipe fitting).	○ 861411	55x36	24,8
	<b>Bidet</b> <b>Bidet</b>	Bidet monoforo con foro troppopieno. One taphole bidet with overflow hole.	○ 8662111	55x36	20,8
	<b>Sedile Slim "soft-close"</b> <b>Seat &amp; cover Slim "soft-close"</b>	Sedile "Soft-Close" Slim in resina termoindurente. Seat & Cover "Soft-Close" Slim, in thermosetting resin.	MS86CSN11	-	2,8
	<b>Sedile "soft-close"</b> <b>Seat &amp; cover "soft-close"</b>	Sedile "Soft-Close" in resina termoindurente. Seat & Cover "Soft-Close", in thermosetting resin.	MS86CN11	-	3,3
	<b>Sedile</b> <b>Seat &amp; cover</b>	Sedile in resina termoindurente. Seat & Cover, in thermosetting resin.	MS86N11	-	3,3
	<b>Piletta</b> <b>Drain</b>	Piletta con chiusura a scatto. Finitura cromo. Drain with snap closure. Chrome finish.	PILL	1" 1/4	0,45
	<b>Piletta in Ceramica</b> <b>Ceramic Drain</b>	Piletta con chiusura a scatto per lavabo con foro troppopieno, corpo in ottone e coperchio in ceramica. Drain with snap closure for basin with overflow, brass body and ceramic cover plate.	PCS11	-	0,65
	<b>Curva tecnica</b> <b>Technical curve</b>	Curva tecnica. Technical curve.	MCURVA	∅11	0,35
		Kit fissaggio curva Fixing kit curve	FISC	-	0,2
	<b>Placca di chiusura</b> <b>Chromed plate</b>	Placca cromata per copertura del foro troppopieno. Chromed plate for overflow covering.	PCT	-	0,05
	<b>Kit di fissaggio</b> <b>Fixing screw</b>	Kit di fissaggio orizzontale per wc o bidet. Finitura cromo e bianco. Consigliato. Fixing screw horizontal for wc or bidet. Chrome and white finish. Recommended.	FVB	-	0,1



68x36 - 861711

○ Bianco lucido  
Glossy white

68x36<sup>a</sup>  
**861711**



68x36<sup>b</sup>  
**861711**











extraglaze®

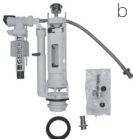

quickrelease



softclose

Dimensione Dimension (cm)	Componente Component	Descrizione Description	○ Cod.	Cm	Kg	185	
68x36	<b>Wc monoblocco</b> <b>Close coupled wc</b>	Wc monoblocco con scarico a parete trasformabile a pavimento tramite curva tecnica non a corredo. Close coupled wc with horizontal outlet convertible to floor outlet through a technical curve not included in set.	○ 861711	68x36 h46	31,8		
	 a	<b>Scocca in ceramica</b> <b>Ceramic cover for plastic cistern tank</b>	Copertura in ceramica con predisposizione entrata acqua dal retro, laterale destra o sinistra per meccanismo anticondensa. Ceramic cover pre-arranged for water entry from the back, lateral left or right for anti-condensation mechanism.	869111	13x35,5	9,7	
	 a	<b>Batteria di scarico anticondensa</b> <b>Anti-condensation mechanism</b>	Batteria di scarico anticondensa doppio flusso 3/6 lt. con entrata acqua laterale e posteriore. Finitura cromo. Anti-condensation mechanism with dual flush 3/6 lt with bottom, side, and back water entry. Chrome finish.	BSCR	-	2,1	
	 b	<b>Cassetta</b> <b>Cistern</b>	Cassetta per monoblocco con entrata acqua dal retro, dal basso o dall'alto (predisposizione destra o sinistra). Cistern for cc pan with back, high or bottom water entry (prearranged for right or left).	868111	17x31 h43	13,5	
	 b	<b>Batteria di scarico</b> <b>Mechanism</b>	Batteria di scarico doppio flusso 3/6 lt. con entrata acqua bassa, laterale e posteriore. Finitura cromo. Mechanism with dual flush 3/6 lt with bottom, side, and back water entry. Chrome finish.	BPCDF	-	1,65	
		<b>Sedile Slim "soft-close"</b> <b>Seat &amp; cover Slim "soft-close"</b>	Sedile "Soft-Close" Slim in resina termoindurente. Seat & Cover "Soft-Close" Slim, in thermosetting resin.	MS86CSN11	-	2,8	
		<b>Sedile "soft-close"</b> <b>Seat &amp; cover "soft-close"</b>	Sedile "Soft-Close" in resina termoindurente. Seat & cover "Soft-Close", of thermosetting resin.	MS86CN11	-	3,35	
		<b>Sedile</b> <b>Seat &amp; cover</b>	Sedile in resina termoindurente. Seat & cover, of thermosetting resin.	MS86N11	-	3,35	
		<b>Curva tecnica</b> <b>Technical curve</b>	Curva tecnica. Technical curve.	MCURVA	∅ 11	0,35	
			Kit fissaggio curva Fixing kit curve	FISC	-	0,2	
	<b>Curva tecnica a S</b> <b>Technical curve S</b>	Curva tecnica a S per wc e wc monoblocco, con fissaggio. Technical curve S shape for cc pans with fixing included.	MCURVAS	∅ 11	0,9		
	<b>Kit di fissaggio</b> <b>Fixing screw</b>	Kit di fissaggio orizzontale per wc o bidet. Finitura cromo e bianco. Consigliato. Fixing screw horizontal for wc or bidet. Chrome finish and white. Recommended.	FVB	-	0,1		



# Lavabi

## Element Free

### Washbasins

## Element Free

56x40  
**75590PF11**

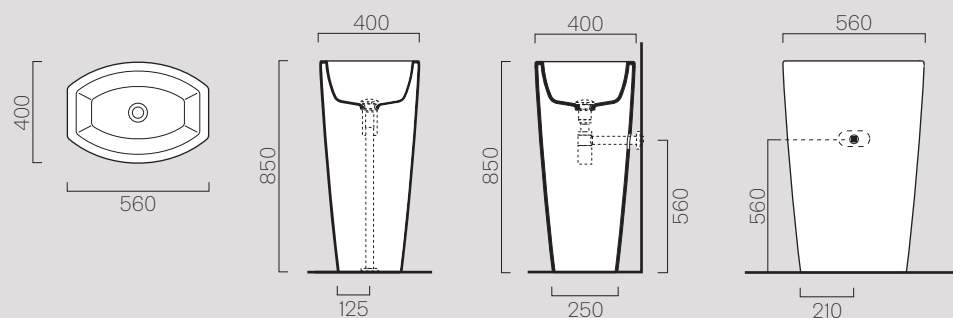

Description	Washbasin
Code	<b>75590PF11</b>
	<b>75580PF11</b>
Dimensions	56x40 h85
Weight	Kg 47,2
Capacity	Lt 14
Overflow	CL 00
Installation	freestanding
Taphole	0

56x40  
**75571PF11**

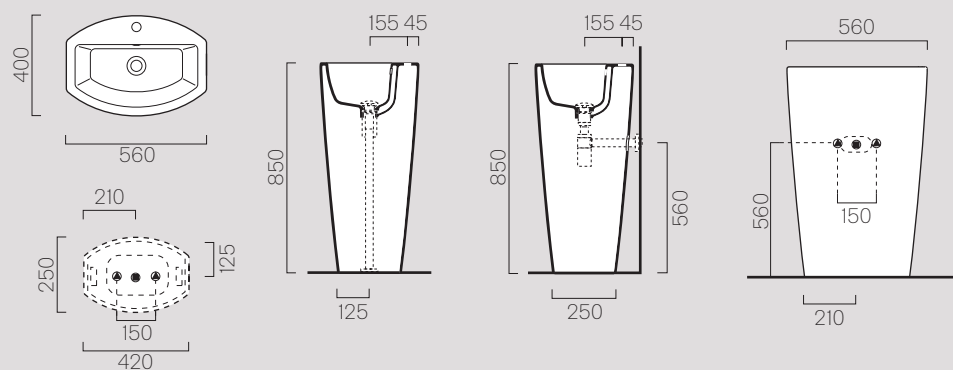

Description	Washbasin
Code	<b>75571PF11</b>
	<b>75561PF11</b>
Dimensions	56X40 h85
Weight	Kg 49
Capacity	Lt 10
Overflow	CL 25
Installation	freestanding
Taphole	1

# Lavabi

## Washbasins

### 125x50

#### 8625111

Description	Washbasin
Code	<b>8625111</b>
Dimensions	125x50 h18
Weight	Kg 34,8
Capacity	Lt 8
Overflow	CL 25
Installation	wall-hung, built-in
Taphole	1 (3)

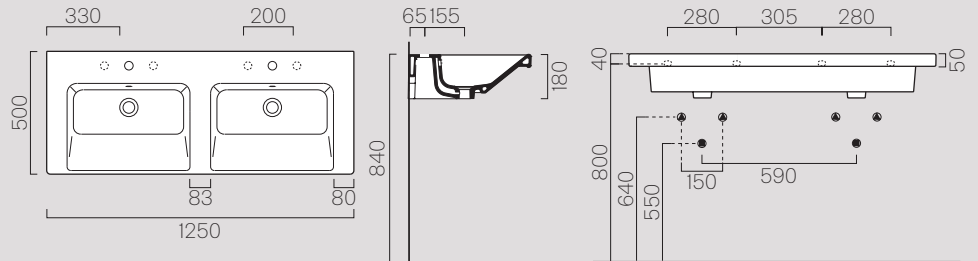

### 120x50

#### 8624111

Description	Washbasin
Code	<b>8624111</b>
Dimensions	120x50 h18
Weight	Kg 30
Capacity	Lt 14
Overflow	CL 25
Installation	wall-hung, built-in
Taphole	1 (5)

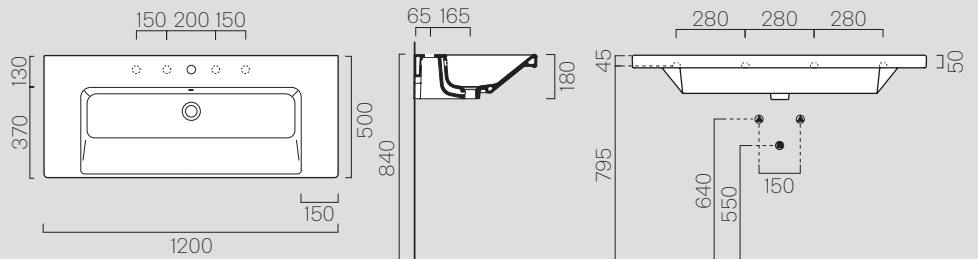

### 100x50

#### 8623111

Description	Washbasin
Code	<b>8623111</b>
Dimensions	100x50 h18
Weight	Kg 26
Capacity	Lt 9,5
Overflow	CL 25
Installation	wall-hung, built-in
Taphole	1 (3)

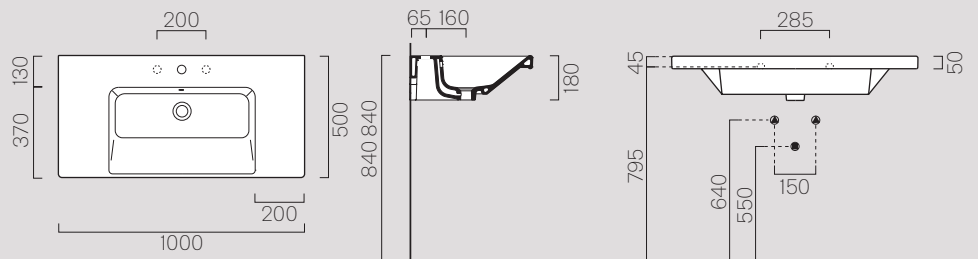



## 90x50

### 8688111

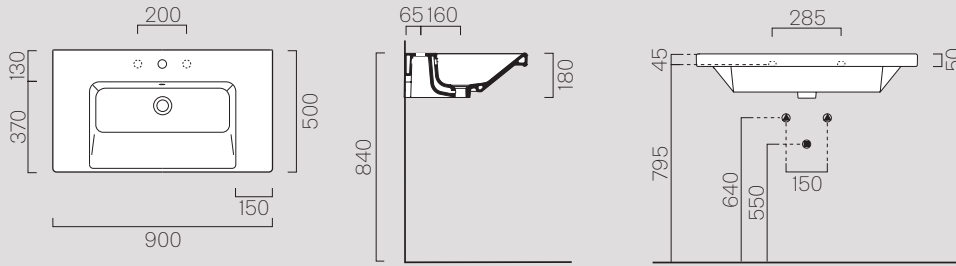

Description	Washbasin
Code	<b>8688111</b>
Dimensions	90x50 h18
Weight	Kg 24,6
Capacity	Lt 9,5
Overflow	CL 25
Installation	wall-hung,
	built-in
Taphole	1 (3)

## 75x50

### 8687111

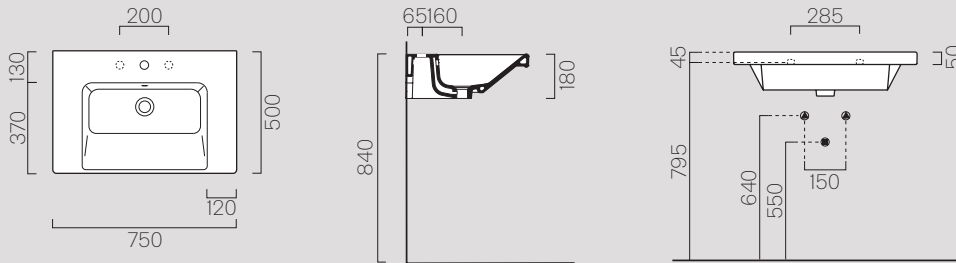

Description	Washbasin
Code	<b>8687111</b>
Dimensions	75x50 h18
Weight	Kg 20,1
Capacity	Lt 8,5
Overflow	CL 25
Installation	wall-hung,
	built-in
Taphole	1 (3)

## 60x50

### 8683111

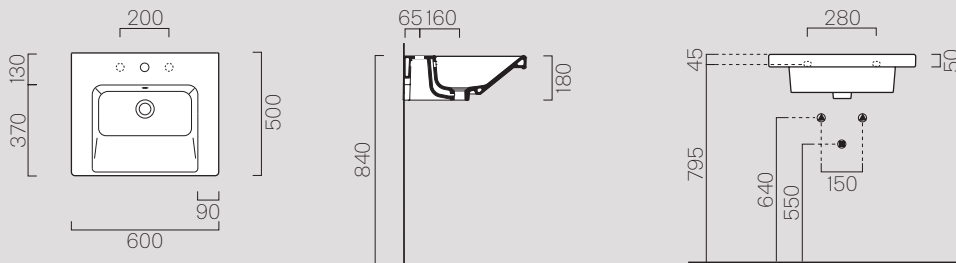

Description	Washbasin
Code	<b>8683111</b>
Dimensions	60x50 h18
Weight	Kg 18,1
Capacity	Lt 6,5
Overflow	CL 25
Installation	wall-hung,
	built-in
Taphole	1 (3)

## 70x40

### 8632111

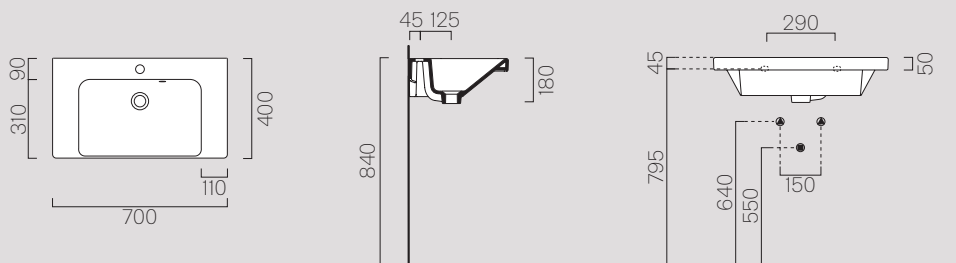

Description	Washbasin
Code	<b>8632111</b>
Dimensions	70x40 h18
Weight	Kg 15,3
Capacity	Lt 7
Overflow	CL 25
Installation	wall-hung,
	built-in
Taphole	1

## 60x40 863111

Description	Washbasin
Code	<b>863111</b>
Dimensions	60x40 h18
Weight	Kg 12,5
Capacity	Lt 6
Overflow	CL 25
Installation	wall-hung, built-in
Taphole	1

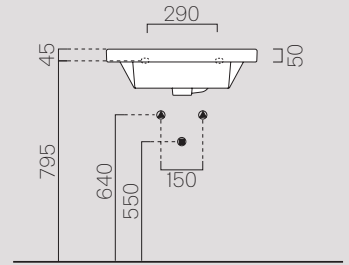
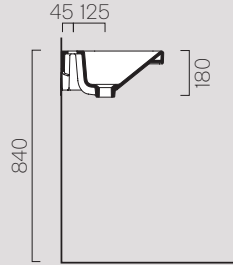
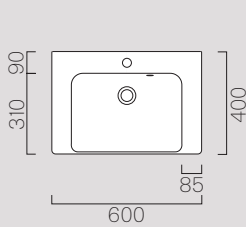

## 50x40 8630111

Description	Washbasin
Code	<b>8630111</b>
Dimensions	50x40 h18
Weight	Kg 10,5
Capacity	Lt 4
Overflow	CL 25
Installation	wall-hung, built-in
Taphole	1

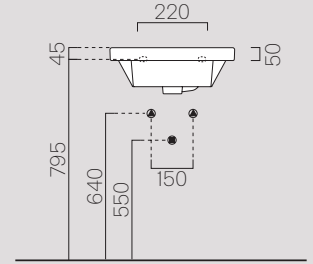
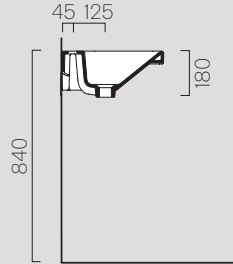
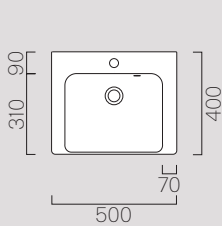

## 42x34 8684111

Description	Washbasin
Code	<b>8684111</b>
Dimensions	42x34 h17
Weight	Kg 9,1
Capacity	Lt 3
Overflow	CL 25
Installation	wall-hung, built-in
Taphole	1

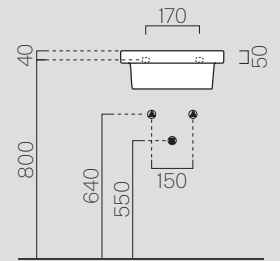
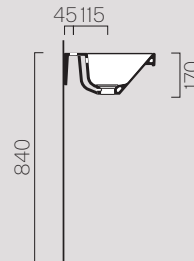
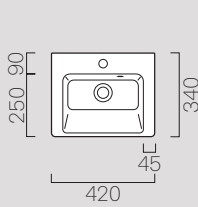

## 35x26 8650111

Description	Washbasin
Code	<b>8650111</b>
Dimensions	35x26 h12
Weight	Kg 5,6
Capacity	Lt 1,8
Overflow	CL 00
Installation	wall-hung, built-in
Taphole	1

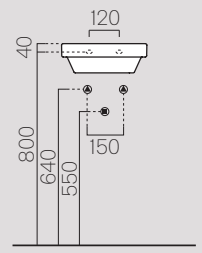
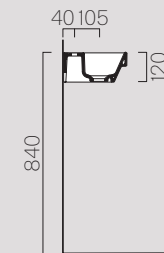
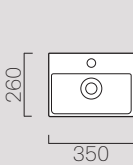

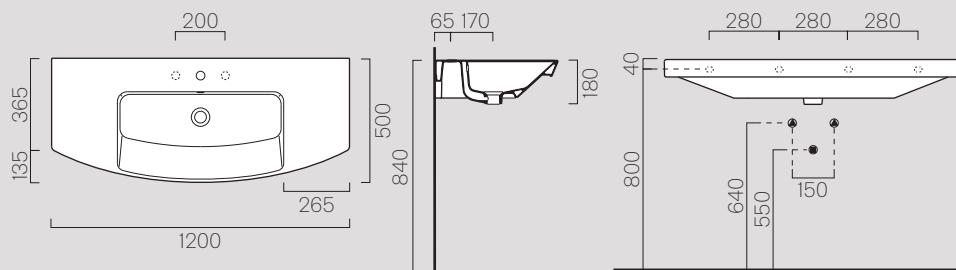

Description	Washbasin
Code	<b>7724111</b>
Dimensions	120x50 h18
Weight	Kg 29
Capacity	Lt 11
Overflow	CL 25
Installation	wall-hung,
	built-in
Taphole	1 (3)

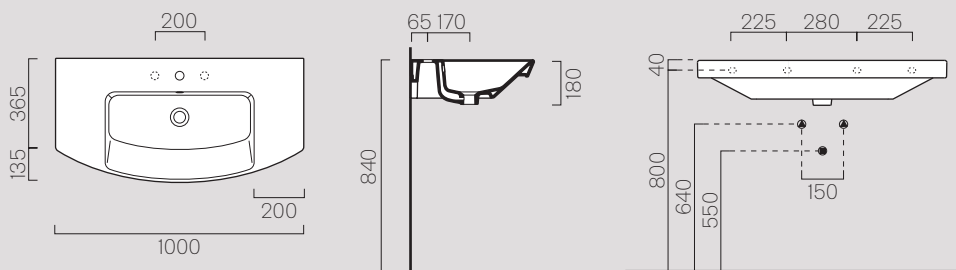

Description	Washbasin
Code	<b>7723111</b>
Dimensions	100x50 h18
Weight	Kg 24,6
Capacity	Lt 9,5
Overflow	CL 25
Installation	wall-hung,
	built-in
Taphole	1 (3)

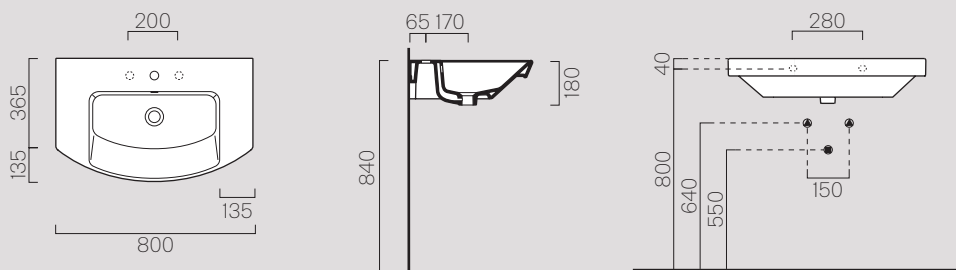

Description	Washbasin
Code	<b>7722111</b>
Dimensions	80x50 h18
Weight	Kg 21,1
Capacity	Lt 9
Overflow	CL 25
Installation	wall-hung,
	built-in
Taphole	1 (3)

## 65x50

### 7732111

Description	Washbasin
Code	<b>7732111</b>
Dimensions	65x50 h18
Weight	Kg 20,1
Capacity	Lt 8,5
Overflow	CL 25
Installation	wall-hung, built-in
Taphole	1 (3)

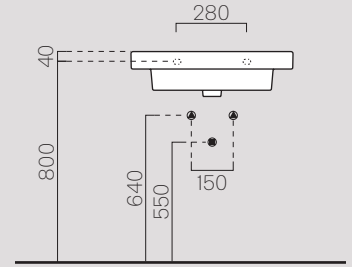
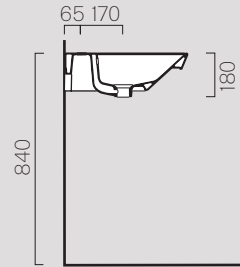
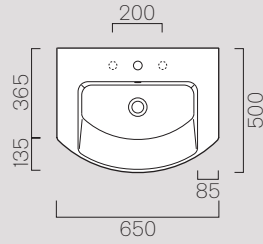

## 50x40

### 7785111

Description	Washbasin
Code	<b>7785111</b>
Dimensions	50x40 h18
Weight	Kg 11,4
Capacity	Lt 5
Overflow	CL 25
Installation	wall-hung, built-in
Taphole	1

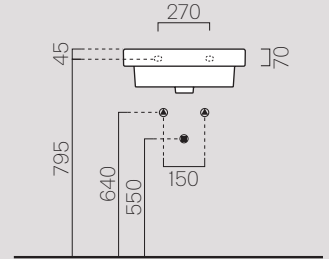
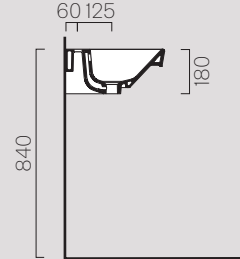
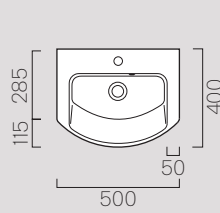

# Wc e Bidet

## Wc and Bidet

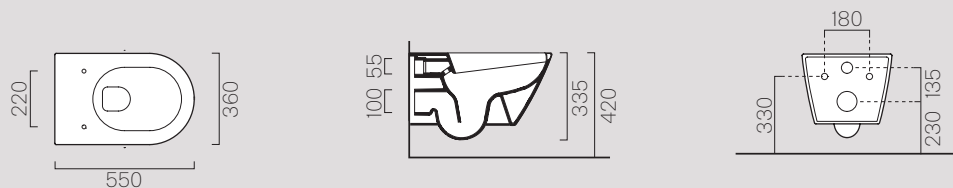

55x36/F  
**861511**

Description	Wc
Code	<b>861511</b>
Dimensions	55x36
Weight	Kg 23,7
Flush system	Swirlflush
Installation	wall-hung

Non è consigliato l'impiego di cassette di scarico esterne o impianti dotati di rubinetto flussometro.  
We do not recommend the use of external flushing cisterns or systems endowed with flushometer valves.

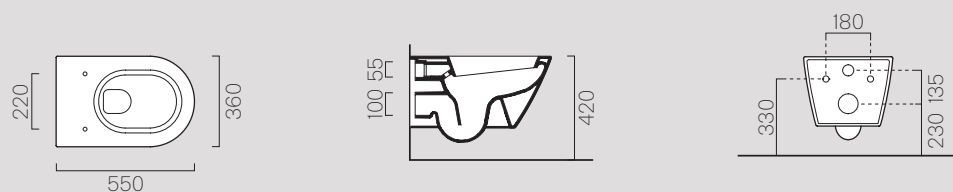

55x36  
**861211**

Description	Wc
Code	<b>861211</b>
Dimensions	55x36
Weight	Kg 24
Flush system	Standard
Installation	wall-hung

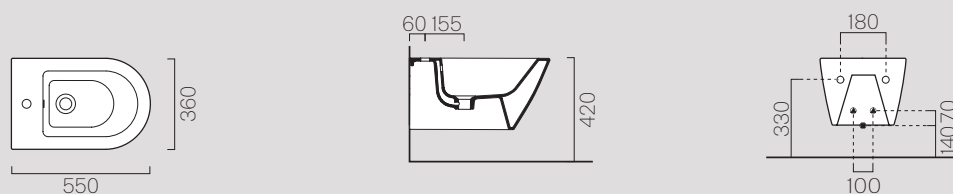

55x36  
**866511**

Description	Bidet
Code	<b>866511</b>
Dimensions	55x36
Weight	Kg 16,3
Overflow	CL 25
Installation	wall-hung
Taphole	1

50x36/F

**861611**

Description	Wc
Code	<b>861611</b>
Dimensions	50x36
Weight	Kg 22,3
Flush system	Swirlflush
Installation	wall-hung

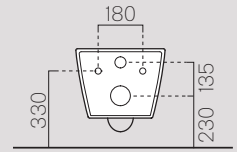
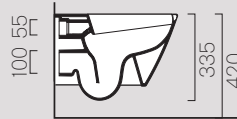
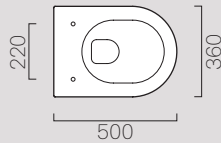

**Non è consigliato l'impiego di cassette di scarico esterne o impianti dotati di rubinetto flussometro.**  
 We do not recommend the use of external flushing cisterns or systems endowed with flushometer valves.

50x36

**861811**

Description	Wc
Code	<b>861811</b>
Dimensions	50x36
Weight	Kg 16,5
Flush system	Standard
Installation	wall-hung

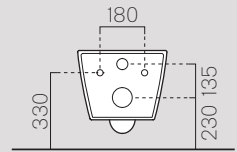
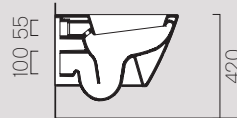
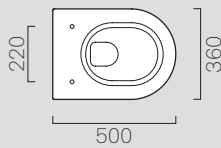

50x36

**8664111**

Description	Bidet
Code	<b>8664111</b>
Dimensions	50x36
Weight	Kg 15,3
Overflow	CL 25
Installation	wall-hung
Taphole	1

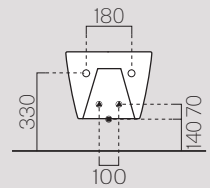
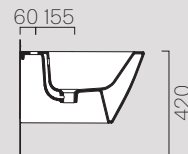
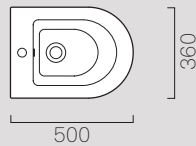

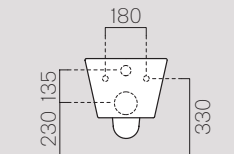
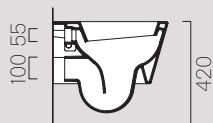
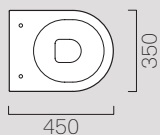
**861011**

Description	Wc
Code	<b>861011</b>
Dimensions	45x35
Weight	Kg 18,6
Flush system	Standard
Installation	wall-hung

## 55x36

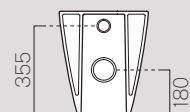
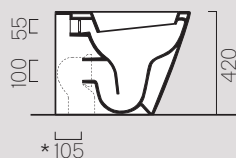
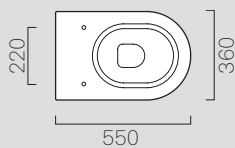
**861411**

Description	Wc
Code	<b>861411</b>
Dimensions	55x36
Weight	Kg 24,8
Flush system	Standard
Installation	Floor standing

**Curva tecnica**  
Technical curve**Codice**  
Codes

MCURVA

MCURVA90

**Interasse**  
Distance

\* 105

\* 60

## 55x36

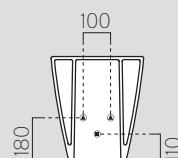
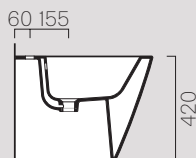
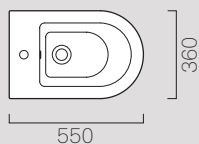
**8662111**

Description	Bidet
Code	<b>8662111</b>
Dimensions	55x36
Weight	Kg 20,8
Overflow	CL 25
Installation	Floor standing
Taphole	1

# 68x36

## 861711

Description	Wc
Code	<b>861711</b>
Dimensions	68x36
Weight	Kg 31,8
Flush system	Standard
Installation	Floor standing

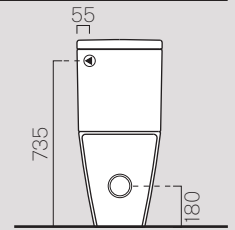
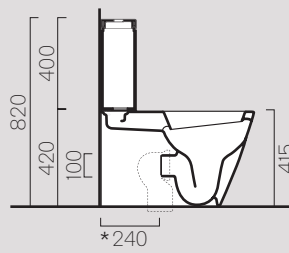
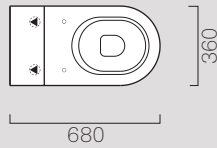

Vista dal retro.  
View from the back.  
Blick von hinten.

**Curva tecnica**  
Technical curve



**Codice**

Codes

MCURVAS

MCURVA90

**Interasse**

Distance

\* Da 230 a 305 mm  
\* From 230 to 305 mm

\* Da 80 a 205 mm  
\* From 80 to 205 mm

# Cassetta

## 868111

Description	Cistern
Code	<b>868111</b>
Dimensions	17x31 43h
Weight	Kg 13,5

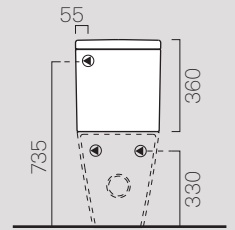
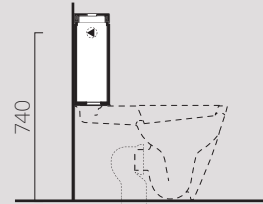
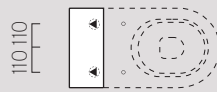

Vista dal retro.  
View from the back.  
Blick von hinten.

# Scocca

## 869111

Description	Ceramic Cover
Code	<b>869111</b>
Dimensions	13x35,5 46h
Weight	Kg 9,6

